

V.H.F. SIGNAL GENERATOR

DECEMBER 1967
Three Shillings

Wireless World

ELECTRONICS • TELEVISION • RADIO • AUDIO

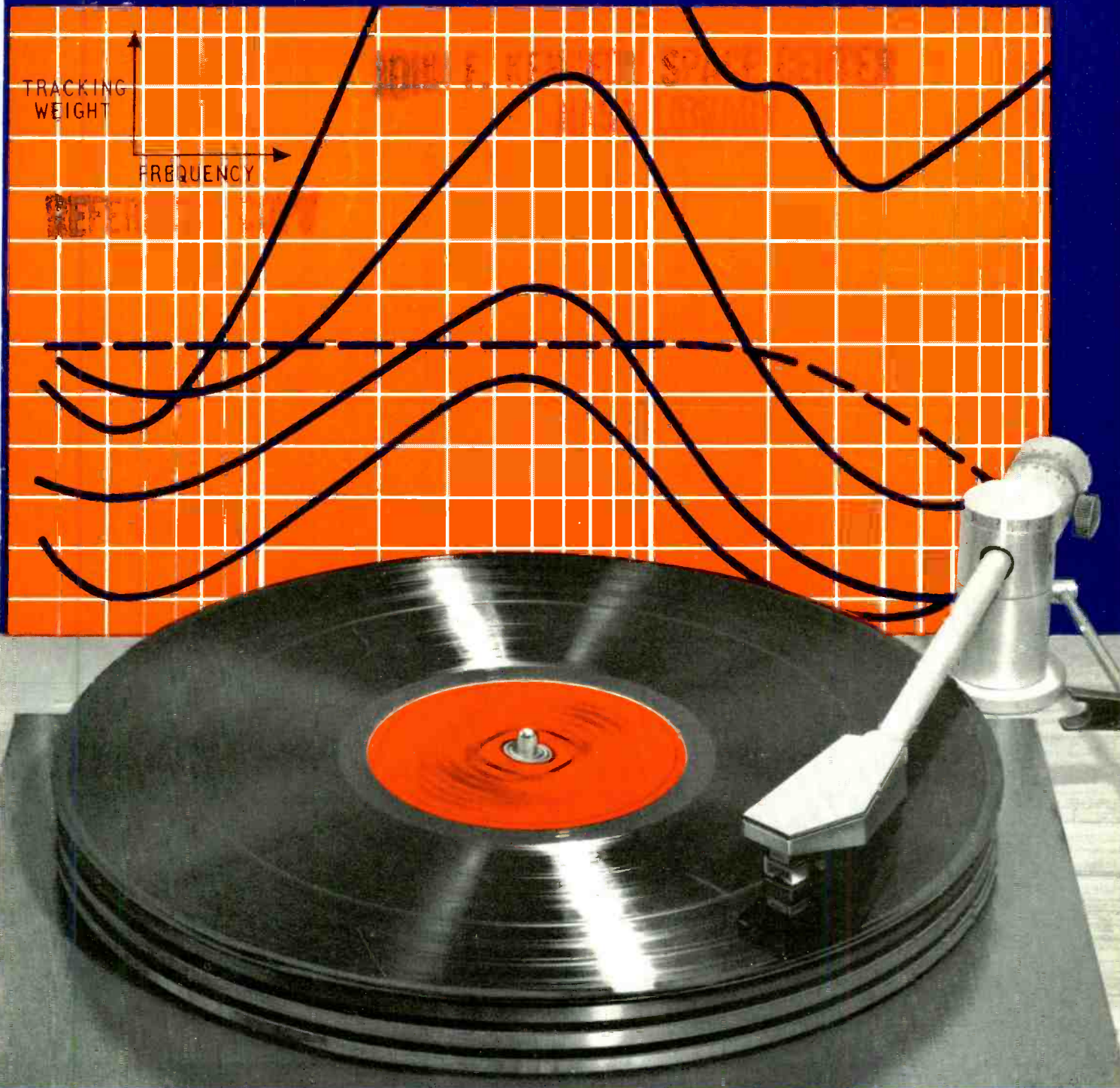

Measuring Pickup Performance

RELAYS

ex stock in 7 days

*C.S.A. APPROVED IN CANADA

***MK**

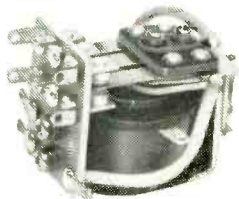

- ★ 3 pole 7.5 amp
- ★ 5 million ops. min.
- ★ **12/4** each per 1000
- Single pole **9/7** each per 1000

- ★ 2 pole 5 amp
- ★ 5 million ops. min.
- ★ **14/8** each per 1000

***MM Contactor**



- ★ 2 pole 15 amps
- ★ 5 million operations minimum
- ★ **17/8** each per 1000

MHP Plug-in relay



- ★ 4 pole, 1 amp
- ★ 100 million operations
- ★ **13/-** each per 1000

SOLDER TERMS

2 pole **8/-** each per 1000

1051



- ★ Snap action microswitch relay
- ★ 7.5 amp, 1 million operations
- Also available in plug-in version
- ★ **7/5** each per 1000

***MKP Plug-in relay**



***MK103**

- ★ Single pole 3 amp
- ★ 1 million operations minimum
- ★ **5/11** each per 1000



MK403P NEW Plug-in relay



- ★ 4 pole 3 amp
- ★ 5 million operations minimum
- ★ **29/-** each per 1000
- SOLDER TERMS
- ★ **21/9** each per 1000

RELAYS

made to measure

APPROVALS: C.E.G.B. No. 131 & 92 · B.R. POST OFFICE KRL · U.K.A.E.A.

P.O. 3000 RELAY

- ★ Manufactured to full G.P.O. specification, also to Industrial Standards
- ★ Contacts up to 30 amp

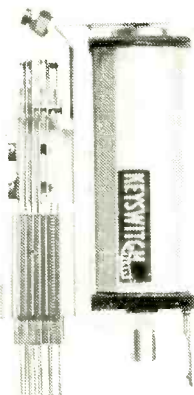

P33 PLUG-IN RELAY

- ★ Plug-in version to BPO 3000 relay, made to measure for Industrial Applications
- ★ Contact ratings up to 10A/750V
- ★ Positive-lock retaining clip
- ★ 30 million operations minimum

P.O. 600 RELAY

- ★ Compact version of BPO 3000 relay
- ★ Contacts up to 10A
- ★ Sensitivities down to 30mW
- ★ Up to 18 contact springs



COMPONENT BOARD P304

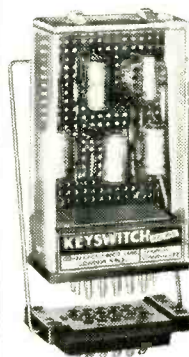

- ★ Plug-in component board unit for low cost, easy chassis fabrication
- ★ **15/-** each per 500
- FROM STOCK

CONTACTOR K700 RELAY

- ★ High-current/high-voltage 3000-type relay
- ★ Contact up to 30A240V a.c.
- ★ Sensitivities down to 45mW
- ★ PTFE armature bar/lifting rods

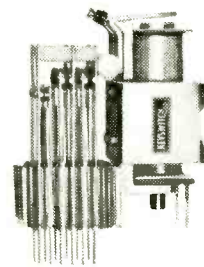

KEYSWITCH RELAYS

KEYSWITCH RELAYS LIMITED

120/132 Cricklewood Lane · London · NW2 · Tel: 01-452 3344
Telex: 262754

WW-001 FOR FURTHER DETAILS

Wireless World

ELECTRONICS, TELEVISION, RADIO, AUDIO

Editor-in-chief:

W. T. COCKING, F.I.E.E.

Editor:

H. W. BARNARD

Technical Editor:

T. E. IVALL

Editorial:

B. S. CRANK

F. MILLS

Drawing Office:

H. J. COOKE

Production:

D. R. BRAY

Advertisements:

G. BENTON ROWELL
(Manager)

J. R. EYTON-JONES

Iliffe Technical Publications Ltd.,
Managing Director: Kenneth Tett
Editorial Director: George H.
Mansell
Dorset House, Stamford Street,
London, S.E.1

Subscribers are requested to notify a change of address four weeks in advance and to return wrapper bearing previous address

© Iliffe Technical Publications Ltd., 1967. Permission in writing from the Editor must first be obtained before letterpress or illustrations are reproduced from this journal. Brief extracts or comments are allowed provided acknowledgement to the journal is given.

VOLUME 73 No. 12

PRICE: 3s.

FIFTY-SEVENTH YEAR
OF PUBLICATION

DECEMBER 1967

- 569 Need for a "Buy British" Policy?
570 V.H.F. Signal Generator *by G. W. Sutton*
576 Class D Principles Analysed *by K. C. Johnson*
581 Measuring Gramophone Pickup Performance *by J. Walton*
594 Diode Function Generators *by A. E. Crump*
601 *Wireless World* Digital Computer—5
609 "Setting up" a Colour TV Set *by T. D. Towers*

SHORT ITEMS

- 589 Air Traffic Control Centre for Southern England
599 Acoustic Domains Scan Image Panels
599 Bolometric Measuring Device
599 Precision True-r.m.s. Indicator
600 High-speed Tape Transport

REGULAR FEATURES

- | | |
|----------------------------|---------------------------|
| 569 Editorial Comment | 600 Literature Received |
| 575 Books Received | 605 HF Predictions |
| 589 World of Wireless | 606 Letters to the Editor |
| 591 Personalities | 608 News from Industry |
| 593 World of Amateur Radio | 613 New Products |
| 599 Technical Notebook | 618 December Meetings |

PUBLISHED MONTHLY (3rd Monday of preceding month). Telephone: 01-928 3333 (70 lines). Telegrams/Telex: Wiworld Iliffepres 25137 London. Cables: "Ethaworld, London, S.E.1." Annual Subscriptions: Home: £2 6s Od. Overseas: £2 15s Od. Canada and U.S.A.: \$8.00. Second-Class mail privileges authorised at New York N.Y. BRANCH OFFICES: BIRMINGHAM: 401, Lynton House, Walsall Road, 22b. Telephone: Birchfields 4838. BRISTOL: 11 Marsh Street, 1. Telephone: Bristol 21491/2. COVENTRY: 8-10, Corporation Street. Telephone: Coventry 25210. GLASGOW: 123, Hope Street, C.2. Telephone: Central 1265-6. MANCHESTER: 260, Deansgate, 3. Telephone: Blackfriars 4412. NEW YORK OFFICE U.S.A.: 300 East 42nd Street, New York 10017. Telephone: 867-3900



MST SUCCESS

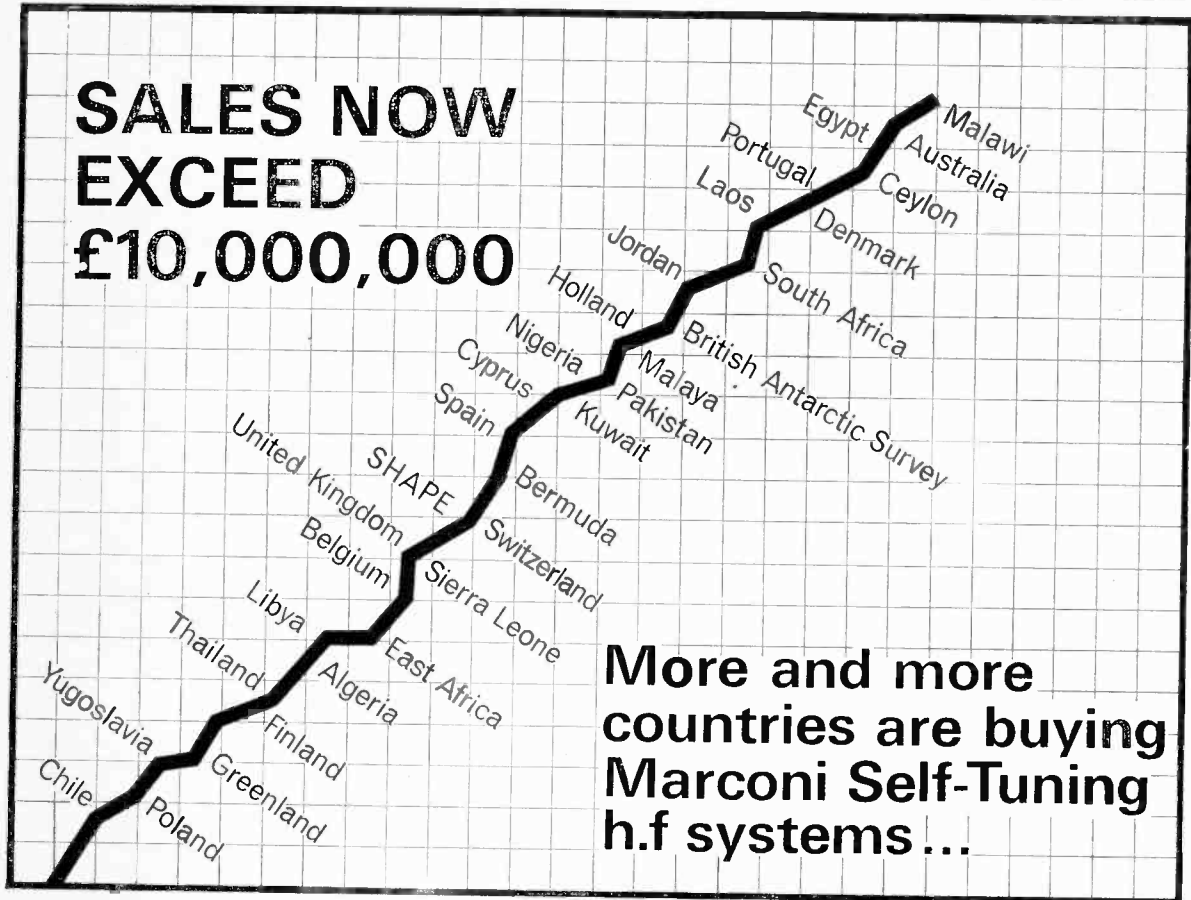

and these are the reasons why:

Reduced capital outlay

MST designs reduce demands for space, and need for standby equipment. Installation costs are decreased.

Increased reliability

Maximum use of solid state techniques plus the use of wideband amplifiers reduces number of moving parts, gives higher reliability and longer equipment life.

Economy of manpower

High equipment reliability together with full remote control facilities permit unmanned station working. Complete h.f. systems can be controlled by one man.

Traffic interruption reduced

Frequency changes and retuning accomplished in less than one minute without loss of traffic.

Marconi telecommunications systems

The Marconi Company Limited, Radio Communications Division, Chelmsford, Essex, England

LTD/H741

WW-114 FOR FURTHER DETAILS

AN 'ENGLISH ELECTRIC' COMPANY

Wireless World

ELECTRONICS, TELEVISION, RADIO, AUDIO

Need for a "Buy British" Policy?

THE year 1968 may well be remembered as the one in which the British electronics industry finally kept its national identity or became predominantly American controlled. Why? Because 1968 will be the year of the integrated circuit, and the i.c. is the heart and substance of future electronics. If the manufacture of i.c.s by British-owned companies does not remain viable, this country's electronics industry will have control of the design of little else besides cabinets, switches, knobs and connectors. The active devices and circuits, and hence the design of equipment, will pass into the hands of U.S. companies.

At present the position is this. The wholly British-owned manufacturers of i.c.s are: Ferranti, Marconi, Plessey, A.E.I. and Welwyn (in rough order of production volume). Elliott-Automation Microelectronics is wholly British but is dependent on an American licence (Fairchild) and may be rationalized with Marconi. The major suppliers wholly controlled from abroad are Texas Instruments (American), Motorola (American) and SGS-Fairchild (Italian and American). A "European-controlled" company is Associated Semiconductor Manufacturers (two-thirds owned by Mullard, a Dutch Philips subsidiary, and one-third by G.E.C.). Further foreign competition, though smaller, comes through R.C.A., S.T.C., Sylvania, Transitron, and Westinghouse.

It has been estimated that the American companies have secured 60-80% of the U.K. market for i.c.s. The actual proportion may be uncertain but there is no doubt that the British manufacturers are in a defensive position. Their technology is behind that of the Americans (perhaps about a year) and their prices are often higher.

The Industrial Reorganization Corporation has recommended to the Ministry of Technology that the British i.c. industry should be rationalized by merging of resources to achieve greater efficiency and competitiveness. Many of the companies, however, look on this idea with disfavour, preferring to "go it alone" and take the risk that some of them may be forced out of business. One firm we spoke to thought that the Government should introduce legislation similar to the "Buy American Act". In the U.S.A., it was pointed out, quite senior engineers have to go to considerable lengths to satisfy official objections before they are allowed to buy even technically superior electronic products from abroad, whereas in the U.K. any junior engineer can order products from American firms with the greatest of ease, and with no check on whether he has looked to see if equivalent British-made products are available. Better support from Government buying of i.c.s was also urged.

Other U.K. firms have pointed out two factors which may prove to be valid or may be just whistling in the dark: (1) With the more complex types of integrated circuits, such as l.s.i., very close co-operation will be needed between device manufacturers and equipment designers. British i.c. manufacturers should score here because they are near at hand and do not have to refer important decisions to America. (2) The formation of big groups through mergers in the electrical/electronics industry will provide better opportunities for tied "in-house" manufacture of i.c.s, with plenty of commercial outlets in extensive ranges of consumer and professional products. The recent A.E.I.-G.E.C. merger may well provide such a situation.

But whatever happens, the responsibility of the individual design engineer or technician is clear, and we say this to our readers: Stop and think. Before buying a foreign product always check first to see whether a British one of equivalent price and performance is available.

VOL 73 NO 12
DECEMBER
1967

WIRELESS WORLD, DECEMBER 1967

569

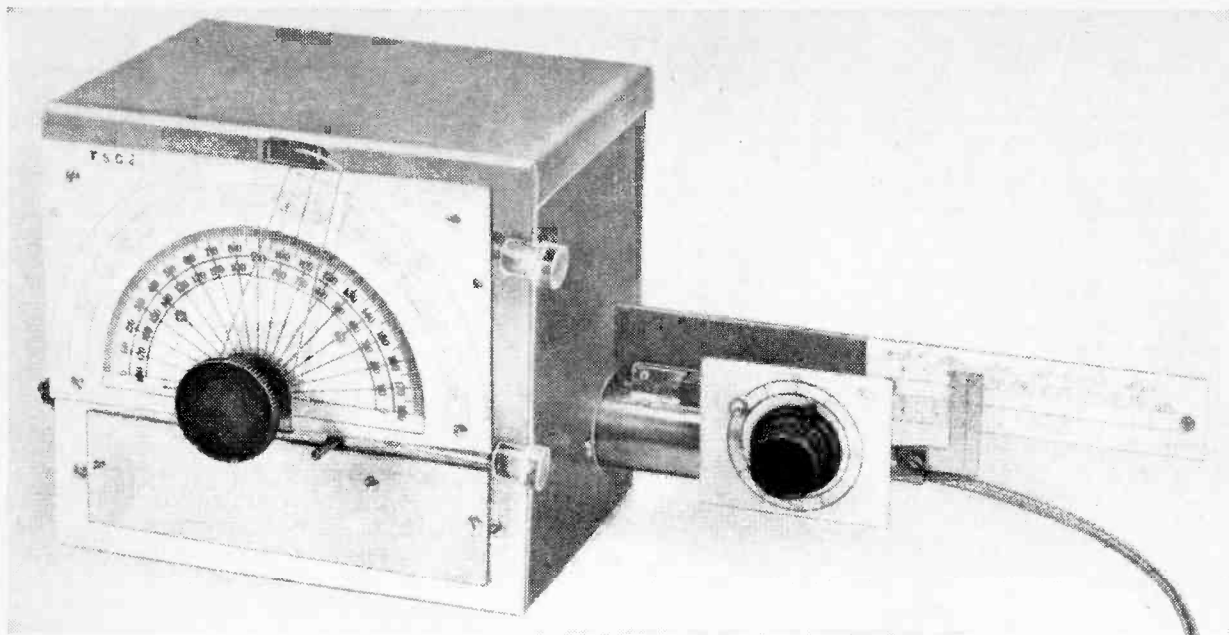

VHF Signal Generator

By G. W. SUTTON,
B.Sc., Ph.D.(Eng.), M.I.E.E.

Design for amateur construction: covers Bands I, II and III: uses calibrated piston attenuator for smooth control of output level

SOME eight years ago the author decided to increase the range of his signal generators to cover the broadcast Bands I, II and III; i.e. 30 to 250 Mc/s. A design target was drawn up, but its fulfilment took much longer than was expected and several models were built and abandoned before the one to be described in this article was achieved. It is hoped that a brief description of some of the discarded features, as well as of the final design, may help other amateurs to avoid wasted time and expense, as well as to provide themselves with a useful little s.g.

THE DESIGN TARGET

(1) Since the apparatus is intended for use in the restricted space of a "spare bedroom" laboratory, it is essential that it should be as light and compact as possible. Receivers under test are usually surrounded by output meters and voltmeters, and every additional piece of test-gear adds to the confusion. Modern TV receivers, like modern motor cars, are not built with repair and maintenance, and easy accessibility of the component parts, in mind.

(2) The second point of major importance is to provide a smooth control of the output voltage from about 100 mV to 1 μ V or less. A total attenuation of 100 dB is therefore required. It is customary and convenient to build such an attenuator in four or five steps of

20 dB, together with one unit containing either ten 2 dB steps or twenty 1 dB steps. Another popular solution is to connect the output from the main oscillator to a wire-wound variable resistor of about 100 Ω —frequently described as a "non-inductive potentiometer," though it is in no sense a meter; nor is it effectively non-inductive at more than a few thousand c/s.

(3) A third essential feature is adequate screening. Unless this is achieved the signal fed to a receiver under

The title picture is of the complete signal generator, showing on the right the piston attenuator and its coaxial output lead.

G. W. Sutton, before retiring in 1960, was director of A.E.I. (Woolwich) research laboratories. Leaving the regular army in 1919, he joined Johnson & Phillips to work on e.h.t. cables. From 1921 he was a lecturer at City and Guilds College then in 1930 went to Siemens to direct research on telephone apparatus. During the second world war he was at R.A.E. and T.R.E. and in 1947 became chief superintendent at S.R.D.E., where he remained till 1954.



test becomes uncontrollable when an attempt is made to reduce it to tens of mV or less. Screening consists of much more than merely shutting the oscillator in an aluminium box. Currents may be induced in the metal sides of such a box, which, in their turn, set up electromagnetic fields on the *outside*. Part of these fields is radiated—the amount radiated increases rapidly with frequency—and will certainly be accepted by some part of the circuit of the receiver under test and appear as a contribution to the “received signal.” It must be remembered that some five to ten v.h.f. volts will be present on some parts—e.g. the fixed vanes of the tuning capacitor—of the oscillator, while it may be required to transmit only a fraction of a microvolt to the input terminals of the receiver. This is a matter of parts in ten million or more.

The first step in reducing leakage to a minimum is to use a double screen. The oscillator circuit is enclosed, as completely as possible, in one box or shield. This in its turn is placed inside an outer box, which must also contain the power unit, either in the form of a battery or a mains transformer with its rectifier and all the necessary components. The inner box must be insulated from the outer one, and separated from it by a centimetre or so. The second step concerns “earthing.” The oscillator circuit should be connected to its container *at one point only* in order to reduce stray currents to a minimum. This calls for careful arrangement of the various v.h.f. by-pass capacitors. The inner shield must, in its turn, be connected to the outer shield *at one point only*, and this should be close to the socket through which the v.h.f. energy is taken from the instrument. Unless this is done there will be small currents flowing in the shielding sheet between the various points at which by-pass capacitors etc., are “earthed.” These will obviously set up electromagnetic fields outside the shield.

(4) In the author's view a third facility should be provided. It should be possible to switch the oscillation on and off without having to wait, after switching on, for the set to “warm up.” This enables one to ascertain quickly whether a reading on the output meter connected to the receiver under test arises in fact from the s.g., and not from some extraneous source. It is obviously important that both frequency and the s.g. power output should return to their previous values within a second or two of switching on again.

(5) The final point in the design target was that the s.g. should operate on the fundamental frequency of the oscillator; and not, as is the case with some commercial models, on the second harmonic.

DEVELOPMENT

When development work started no transistors were readily available for operation at v.h.f., but there was a wide range of suitable pentodes, triodes and grounded-grid triodes. This meant that a mains power unit had to be accommodated in the outer shield, which was 12 in by 8 in by 6 in deep—much larger than was desired. A carefully designed filter was of course necessary at the point of entry of the mains lead to avoid v.h.f. radiation from the mains cable.

The circuit followed current practice of the period. A small coupling coil, fixed close to the oscillator coil, was connected by carefully shielded leads to a 100 Ω “n.i. potentiometer.” The output from the sliding contact was taken to a resistor attenuator of 75 Ω characteristic impedance, disposed on a bank of Oak switches to give steps of 10 dB. The coupling coil was of small

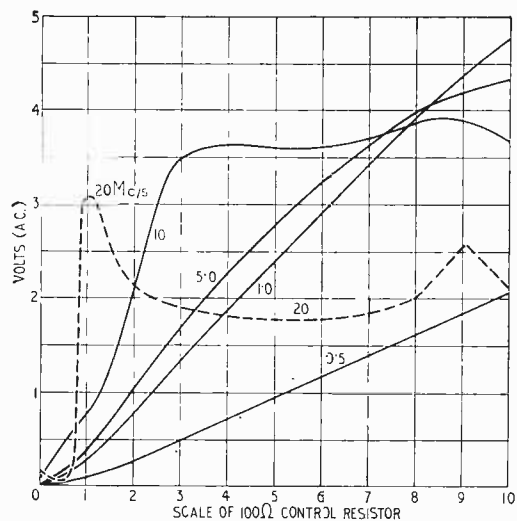

Fig. 1. Characteristics of output control variable resistor at different frequencies.

inductance, compared with the oscillator coil, so as to avoid serious mis-match at the point of connection with the attenuator.

Although this signal generator was put to good use for a period, mainly in aligning the i.f. circuits of TV receivers, it was by no means a pleasure to use. It had three serious faults; faults which the author has noted in varying degree in several commercial signal generators.

- (1) The control of the variable resistor was very non-linear.
- (2) The leakage was frequently troublesome.
- (3) The frequency was affected by changes in the load impedance, particularly at the higher end of the output scale.

The first fault is illustrated in Fig. 1. The readings shown were made on the output from a wavemeter which was at one time widely used by the R.A.F. (the W1191). This wavemeter has eight ranges, and covers 100 kc/s to 20 Mc/s. On the lower four ranges the characteristic of the control resistor is linear, and the voltage output at the zero end of the scale is negligible. This is shown by the curve marked 0.5 Mc/s. But at higher frequencies the characteristic becomes very distorted, until at 20 Mc/s it can be seen that there is significant output with the control at “zero.” In fact residuals of the wire-wound strip of the variable resistor make it a sort of transmission line, the characteristic of which is greatly affected by the position of the sliding contact.

It was thought that these faults might be reduced by isolating the coupling coil from the attenuator by means of a grounded grid triode used as a cathode follower. This was tried without appreciable success in the second model made.

Incorporation of transistors.—At the time when these disappointing results were encountered several transistors suitable for use at v.h.f. had become freely available. A new model generator was therefore built to take advantage of this. The size of the outer case was reduced to 9 in × 5 in × 9 in high. This contained four separately shielded units:—

- (1) a BSY26 battery driven v.h.f. oscillator;
- (2) a simple OC72 battery driven 1 kc/s modulator;

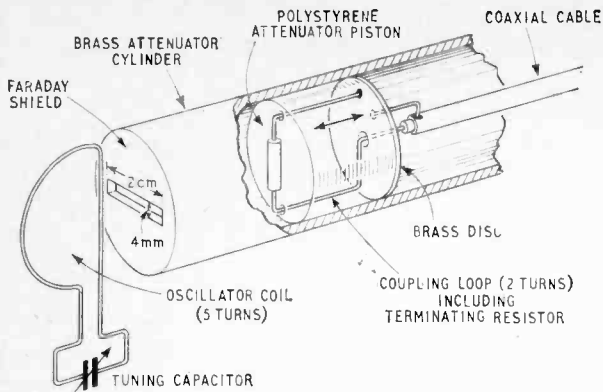
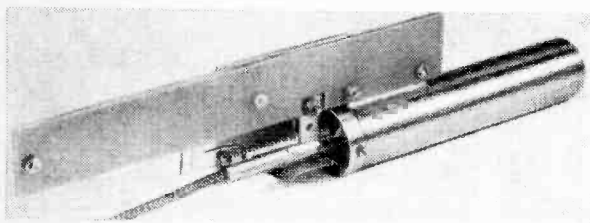

Fig. 2. Arrangement of piston attenuator and oscillator tank coil.



Rear view of piston attenuator, showing rack of rack-and-pinion by which piston is moved by rotary control.

- (3) a "separator" unit consisting of an EC70 (sub-miniature u.h.f. triode) connected as a cathode follower and supplied by a small mains unit;
- (4) a $100\ \Omega$ variable resistor feeding a keyed 100 dB attenuator.

It was hoped that with better matching conditions, and perhaps with the application of some phase-adjusting capacitors, the variable resistor might prove less unsatisfactory than is shown in Fig. 1.

Various transistor "separator" circuits were considered as replacements for the EC70 in (3) above, but were rejected on the grounds of complexity and battery consumption.

Consideration was also given to the use of capacitor attenuators, but it appeared that, at least for the variable unit, some very precise instrument-making would be needed. Moreover, a suggestion had meanwhile been

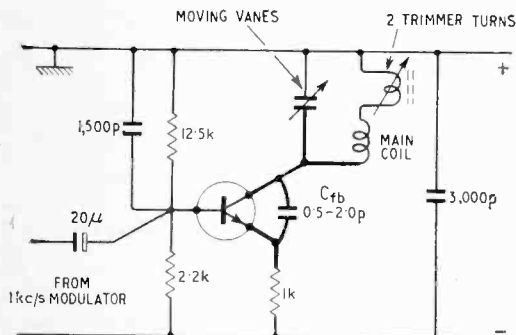

Fig. 3. R.F. oscillator circuit. "Sensitive" wiring is shown by heavy lines.

received from Mr. V. J. Cox of Ekco Electronics that a piston attenuator might well be the simplest answer to the problem.

Piston attenuator and Faraday shield.—When considering the possible application of a piston attenuator some years previously, the author had wrongly concluded that it would need to be the size of a tyre-pump for use in the v.h.f. region, as opposed to its more usual applications in centimetre and millimetre radar. Mr. Cox, however, drew attention to an excellent paper by G. F. Gainsborough (then N.P.L.) published in 1946. In this an attenuator for use at 20 Mc/s is described, and its features examined in some detail. The size is by no means excessive, being $1\frac{1}{2}$ in internal diameter and less than 9 in long. Further, it had only been made as large as this because, for N.P.L. standardization purposes, it was necessary to take readings to about 0.02 dB. It was therefore seen to be possible to secure sufficient accuracy for present purposes by using a tube $\frac{7}{8}$ in internal diameter and $4\frac{1}{2}$ in long. With a suitable rack-and-pinion drive this allows the attenuation to be read with an accuracy of at least 0.5 dB.

An electromagnetic wave, travelling along a cylindrical wave-guide in the $H_{1,1}$ mode of propagation, decreases exponentially in intensity. The attenuation coefficient is $15.99/\gamma$ dB/cm; where γ is the radius of the inner surface of the tube in cm. An ordinary hard-drawn brass tube is sufficiently cylindrical and of sufficient conductivity to provide adequate accuracy in the present application, and a $4\frac{1}{2}$ in length of such tube gives a maximum attenuation of more than 100 dB.

Gainsborough shows that energy in the form of an $H_{1,1}$ wave can be abstracted from the field of an oscillator coil placed close to one end of the tube by means of a single turn coil, coplanar with the first one, that slides backwards and forwards like a piston, within the tube (see Fig. 2). All other coupling between the two coils can be eliminated, to an adequate degree, by closing the end of the tube between the coils by a brass disc with a slot in it. The slot must of course be in a plane perpendicular to that of the two coils, so that, while the magnetic component of the field can pass through the slot, the electric component is stopped by the remainder of the disc. Clearly the size of the slot* is a compromise between admitting as much of the desired radiation as possible, while stopping the undesired electric (or capacitive) coupling between the coils. Gainsborough concludes that, given the dimensions of his apparatus, the side of the coupling loop nearer to the shield should not be allowed to approach the shield closer than 1.5 cm if the exponential relationship between position of piston and induced voltage is to be maintained with sufficient accuracy for his purpose. He suggests moreover that the front end of the coupling loop should consist of a $75\ \Omega$ resistor, so that the transmission line for the output energy is correctly terminated at that end. (It should, of course, be correctly terminated at the other end also.)

The author has found, by comparing the attenuator with another one in the amplifier of a Calibration Receiver, that the piston can be brought to within 3 or 4 mm of the end of the tube since the accuracy demanded is less than in the case of the N.P.L. model, and the dimensions are different. The closeness of approach of the piston to the end of the cylinder is important in the present application, for the reason given below.

Voltage calibration of output.—Gainsborough points out that "A piston attenuator of suitable construction is

* 2.0×0.4 cm.

therefore considered now as a primary standard, in the sense that it is a standard of which the performance is calculated from the dimensions of the instrument." Consequently the output voltage reading needs to be measured only at one position of the piston in order to calibrate the instrument over its whole length. Clearly the position to be used in the present instance is at the point of minimum attenuation, where the output voltage may be expected to come within the range of a diode voltmeter. In fact, with the various components and other quantities suggested below, the maximum output voltage proves to be 150 to 200mV, which is just within the scope of a good diode voltmeter. The remaining readings, down to $1\mu\text{V}$ or less, are based on this. Any error in the calibration will be a constant fraction of the reading right down the scale.

CONSTRUCTION

The dimensions and arrangement of the component parts of the piston attenuator can be seen from Fig. 2 and the photographs. The rear surface of the piston is a thin brass disc with a radial clearance of about 1 mm between its edge and the inner surface of the cylinder. Theoretically the edge of the disc should make good metallic contact with the cylinder, but this involves some rather precise instrument work, and an erratic contact would be worse than a gap. Gainsborough has not traced any error to such a gap at 20 Mc/s, though he considers that metallic contact may be necessary at frequencies of the order of 3000 Mc/s.

Circuits.—Using a silicon planar n-p-n transistor such as the S.T.C. BSY26 or BFY18, the oscillator circuit shown in Fig. 3 has proved to be consistently satisfactory, although great care had to be taken in the arrangement of the wiring. The most sensitive parts of the wiring are, of course, those at high a.c. potential; and these are indicated by thick lines in the diagram. They should be as short as is practicable. The stray capacitance of the wiring largely governs the upper limit of frequency that can be reached; and it must not be overlooked that, at these frequencies, every mm of wire possesses significant self-inductance. It is important to concentrate as much of the total capacitance of the tuned circuit as possible in the tuning capacitor, and as much of the total inductance as possible in the coil.

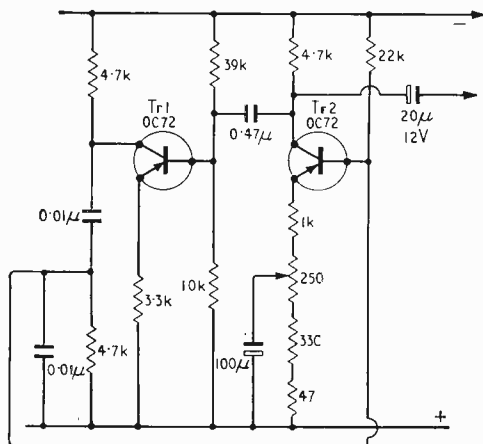

Fig. 4. Audio frequency oscillator circuit for modulation.

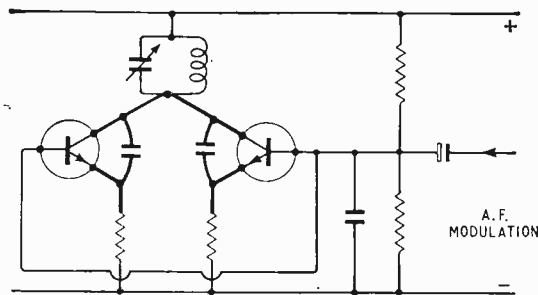

Fig. 5. Twin-transistor r.f. oscillator circuit giving greater output. "Sensitive" wiring is shown by heavy lines.

This will ensure that the 180° swing of the former will embrace the widest possible frequency, and that the maximum field intensity is sited in the coil.

The amount of feedback between collector and emitter necessary to maintain oscillation is provided partly by the stray capacitance between the sensitive portions of the collector and the emitter wiring. If this wiring is kept to just a few mm as has been suggested, a fixed capacitor of between 0.5 and 2.0 pF will probably have to be added, as shown in Fig. 3. The smallest value that maintains oscillation over the whole tuning range should be chosen, in order to ensure a good r.f. waveform.

A rough measure of the intensity of oscillation may be obtained from the d.c. current taken from the battery. The current increases a little as the transistor goes into oscillation. This increase should be kept to a minimum by selecting the smallest fixed capacitor sufficient to maintain oscillation over the whole scale. Anything more will not increase the output voltage at the fundamental frequency significantly, but it will build up harmonics, and it will also affect the tuning.

The rubbing contact between the rotor shaft of the variable capacitor and its frame must be really good, otherwise the output from the s.g. will be variable. A flexible braid pigtail or a coiled spring is sometimes used to short-circuit this contact, but these possess appreciable self-inductance, and are consequently not true short-circuits at v.h.f. After trying several capacitors the author happened to have available, he finally settled for a Jackson Type C 804 for the lower range (30 to 60 Mc/s) and Type C 1604 for the upper range (around 200 Mc/s). These are small in size, particularly the Type C 1604, and have a very robust bearing. There has been no evidence that the rubbing contact of either of them introduces resistance variation into the tuned circuit.

The oscillator coil is wound on a wooden former 3 cm in diameter, with a 2.5 cm flat filed on one side. Five turns of No. 18 s.w.g. wire are tightly wound on to this former and then slipped off. Five pieces of 0.03 in celluloid or perspex, 4 cm \times 3 cm are then placed between successive turns, and two thicker (say 0.1 in) 4 \times 3 cm perspex plates are used as end cheeks to the assembly, which is clamped by a 6 B.A. screw passed through a hole in the centre of each plate. No. 18 s.w.g. wire is 0.048 in diameter, so small celluloid spacing washers, about 0.400 in thick are slipped on to the screw between successive plates. The whole assembly, after a little juggling, can be clamped up to form a self-supporting structure, and cellulose lacquer squirted into the interstices. After the cellulose has dried the 6 B.A. nut can be slackened off and one end-plate removed, giving

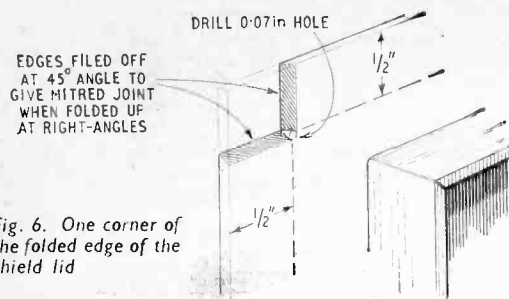

Fig. 6. One corner of the folded edge of the shield lid

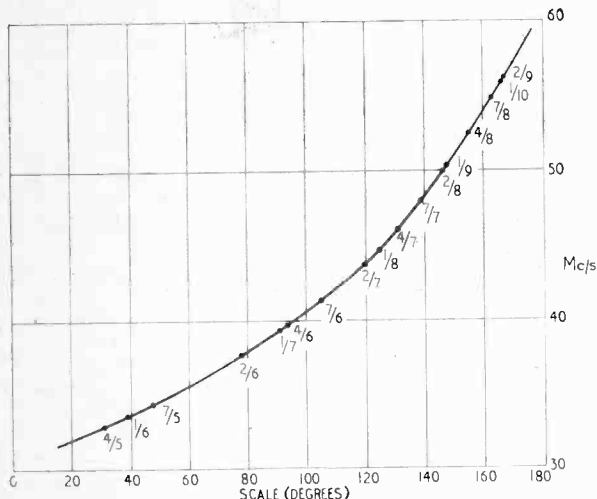

Fig. 7. Frequency calibration for 30-60 Mc/s range. Points marked are beats between the s.g. and crystal harmonics, e.g. 4/7 is the beat with the 4th harmonic of the crystal, the fundamental of which is 6.870 Mc/s.

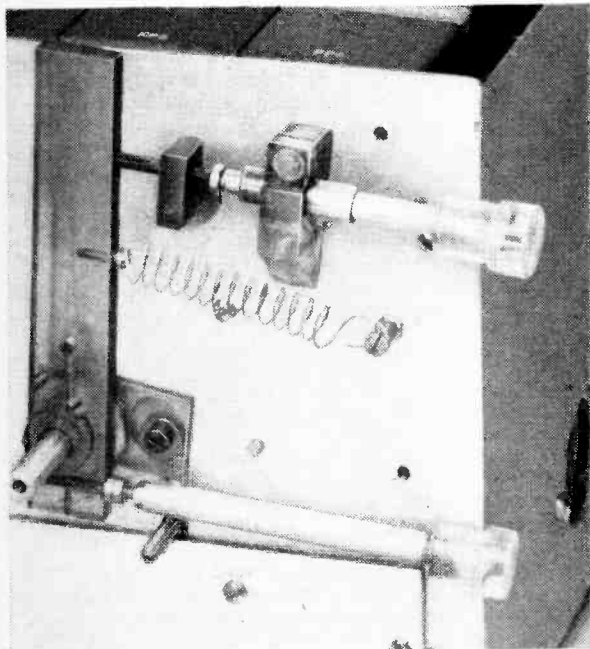

Fig. 8. Front of instrument with scale removed to show construction of slow-motion drive. The upper knob is for slow-motion adjustment and the lower for locking the perspex arm to the capacitor spindle.

access to the end turn. Major adjustments of the coil to bring the frequency to the desired point on the 180° scale of the variable capacitor can be made by bending this end turn and then clamping it again. This construction is not elegant, but it is quickly carried out, is rigid, and ensures a definite spacing (i.e. the thickness of the separators) between turns.

Two "trimmer" turns are also provided at the earth end of the coil. These are wound on any convenient i.f. transformer moulding, with a screwed ferrite core. This enables the instrument to be brought back into calibration after it has been disassembled, the shift of about 1 Mc/s at 40 Mc/s being sufficient for this purpose.

Modulation.—A 1 kc/s modulation voltage can be applied to the base of the r.f. transistor. The base is earthed, so far as r.f. is concerned, since the reactance of the 1,500 pF by-pass capacitor is only an ohm or two at 30 Mc/s. But at 1 kc/s it is about 100 kΩ.

The 1 kc/s modulator is a simple Wien bridge with feedback from the amplifying stage controlled by a 250 Ω variable resistor. The resistance values shown in the emitter branch of this stage in Fig. 4 have been selected, with the OC72 transistors used, to bring the modulator into oscillation at the mid-point of the 250 Ω resistor. On the threshold of oscillation the modulation is found to be about 50%.

Higher output.—The author has found that 150 mV is sufficient for all normal work. For instance, one TV receiver service manual calls for voltages ranging from 15 μV to 60 mV. But it may occasionally be found that a higher output is required. This can be achieved in one of two ways without affecting the basic design of the instrument.

(1) A second BSY26 can be connected in parallel with the first, as shown in Fig. 5 and it will be found that this almost doubles the output voltage. It will also, of course, double the battery drain.

It is essential to make the sensitive leads in this circuit symmetrical, to the last mm of wire. Otherwise the output voltage will be found to fluctuate heavily over the frequency scale. There appears to be no reason why more than two transistors should not be paralleled up in this way, but the author stopped at two!

(2) The piston attenuator can be replaced by a brass tube of the same diameter but without a Faraday shield, and with a coupling coil of several turns on the front end of the piston in place of the 75 Ω resistor. The loss of shielding with this construction is not likely to be important in tests calling for a comparatively high output voltage.

Mechanical features.—It is advisable to use 16 gauge (0.064 in) aluminium sheet for the front and base of the outer case, for the sake of rigidity. This consists of a single sheet of metal with only one right-angle fold. It will be found easier to use 18 gauge (0.048 in) sheet for the remaining panels and top of the outer case, and for the inner shield, unless a steel folding machine is available. A rectangular hardwood block, cut to the inner dimensions of the inner shield, and with its edges rounded off, is a worthwhile device for shaping the front and four sides of this shield.

When folding this, and the overlapping edges of the two lids and the side panels, the author found it useful to adopt the procedure illustrated in Fig. 6. A hole, about 0.07 in diameter, is drilled at the intersection of the lines at which the edges are to be folded down. After

cutting away the corner rectangle the shaded ends of edge pieces are filed off at an angle of 45°. The edges are then folded, which brings the two shaded faces into contact. A few taps with a riveting hammer on the outside is then sufficient to complete a closed joint. It has been found that $\frac{1}{2}$ -in overlap at all edges is sufficient to prevent any troublesome degree of leakage.

Scales.—Opaque white celluloid is a useful material on which to draw the scales. The surface should be roughened with very fine emery cloth. Temporary markings can be made in pencil on the resulting matt surface and these can, of course, be easily rubbed out. Final calibration marks can be made in Indian ink; even this can be rubbed out with fine emery cloth if a mistake is made.

Semi-circular protractors, 4 inches in diameter, can be obtained from Woolworth's for a few pence. One of these is held down on to the celluloid sheet intended for the variable capacitor (i.e., the frequency) scale. It will be found to be sufficiently accurately inscribed for the present purpose, which is to facilitate calibration.

Calibration.—The first step in the frequency calibration of a newly constructed s.g. is to ascertain *approximately* the frequency range over which it is in fact operating. This facilitates the identification of harmonics from a crystal calibrator, or the particular broadcasting station being received when that aid to calibration is being used.

If a wavemeter or s.g. is available, however dubious one may be about the accuracy of its scale, the problem does not arise. If not, provided the dimensions given above have been closely followed, the curve given in Fig. 7 will provide a satisfactory starting point.

The author happened to have several quartz crystals in the range 5 to 10 Mc/s available, and this is probably true of many other amateurs, since these have been made in large quantities for the Services and released as surplus. Harmonics up to the 30th can be identified and used for calibrating the s.g. without much trouble. If the readings obtained are plotted on a double foolscap sheet of graph paper, with the protractor readings as ordinates, the angles necessary to mark off the s.g. scale can be conveniently and accurately read from the graph.

Variable capacitor reduction drive.—When calibrating by beat-notes, and when measuring frequency drift, it is most useful to have a reduction drive. On the other hand it is almost essential to be able to sweep across part or the whole of the frequency range by direct drive. A permanently engaged reduction gear is therefore unsuitable.

A simple reduction drive has therefore been fitted. Its construction will be obvious from Fig. 8. Using a 6 B.A. screw about an inch long, a sweep of about 1 Mc/s on the 30-60 Mc/s range is available, at any point on the scale. Although no particular care was taken in its construction it is as smooth in action as more professional devices which the author has used, and it can be instantly unclamped without disturbing the capacitor setting.

Batteries.—The model described has space for four Ever Ready PP6 dry batteries, supplying approximately 36 V to the r.f. oscillator, and 9 V to the modulator. The r.f. oscillator frequency rises as the battery volts fall, the rate of increase being 3 to 4 kc/s per volt between 36 and 26 volts. This is not enough to be troublesome in most uses to which the s.g. is likely to

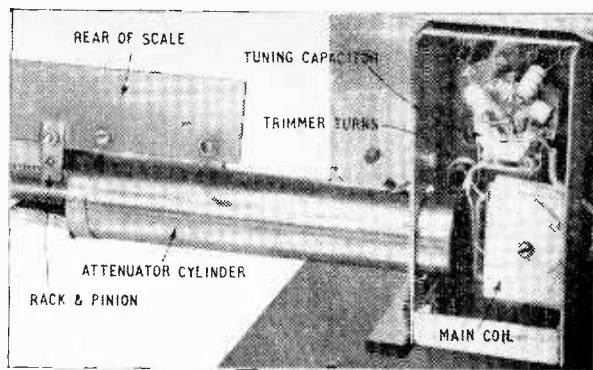

Showing how the piston attenuator is inserted into the oscillator box so that it receives energy from the main coil.

be put, and does not justify the complication of a voltage-regulating device. If, however, the s.g. is to be used for long periods of time the height of the outer case could be increased by $\frac{1}{2}$ in or so to accommodate eight Ever Ready 1289 batteries.

The fall in output with ageing batteries is rather more serious, but in the author's opinion, does not justify the drawbacks of incorporating a mains unit. For the purposes mentioned at the beginning of this article an accurate knowledge of the output voltage is not necessary, provided it remains constant over the frequency-sweep being employed and during the period of the test.

Piston attenuator construction.—Dimensioned drawings to assist in the construction of the piston attenuator can be obtained by writing to *Wireless World* editorial office, enclosing a stamped, addressed foolscap envelope.—Ed.

Books Received

VLF Radio Engineering, by A. D. Watt. From the International Series of Monographs on Electromagnetic Waves, Volume 14. Following the introduction, which provides the necessary background, i.e. terminology—units used—and a brief review of the field, successive chapters cover transmitting aeriels; propagation; receiving aeriels; atmospheric radio noise; modulation, frequency spectrum, receiving systems, and complete systems. Pp. 701. Price 140s. Pergamon Press Ltd., Headington Hill Hall, Oxford.

Transistor Bias Tables (Volume 2, Silicon), by E. Wolfendale. These tables have been prepared on similar lines to those included in the previous volume on germanium transistors. They cover eleven values of collector current, there being six supply voltages for each of these. Other factors taken into account are junction temperature and β . The designer is able to arrive quickly at biasing resistor values for a given set of parameters. Pp. 82. Price 25s. Iliffe Books Ltd., Dorset House, Stamford Street, London, S.E.1.

Dictionary of Electronics, by Peter Neidhardt. Some 17,000 terms in English, German, French and Russian are included in this book. Subjects covered are electronic components; electronics in low-, medium-, video-, high- and very-high frequency techniques; electronic information processing; electrical high- and very-high-power systems; electron and ion systems; and bionics. Pp. 1,660. Price 400s. Pergamon Press Ltd., Headington Hill Hall, Oxford.

1: CLASS D PRINCIPLES ANALYSED

By K. C. JOHNSON, M.A.

THERE have been many articles and letters in this journal over the past few years showing a considerable interest in the possibility of constructing audio transistor power amplifiers and in particular those which employ the class D principle of operation. In a power stage of this type the final devices work as switches, being driven alternately into cut-off, where their current is small, and into saturation, where the voltage across them is small, for all but the fraction of time required for the switching which is also small. In contrast to class A or class B working these transistors never intentionally dissipate any power, although in practice there is always some heating due to the fact that the three quantities called small can never be made negligible. There is a difference from class C working in that the duty-cycle of each device is made to average close to 50% instead of perhaps 10% or less, and thus the power output obtainable is greater when the value is limited by the maximum permissible current and voltages, as is usually the case with transistors. The two systems are similar in that both use switching and both can give high efficiencies. Class C working as usually understood, though, is usable only for generating sinusoidal power with only comparatively slow modulation, while class D can not only do this but can also be adapted to handle complex waveforms including speech and music.

The name class D was originally suggested by P. J. Baxandall who described two separate forms of circuit for generating constant amplitude sine-waves¹. Both use pairs of transistors switched at a frequency equal to that of the output required and having a duty-cycle constant at close to 50%. The essential features of the two circuits are shown in Fig. 1.

The first arrangement, Fig. 1 (a), will be seen to be very similar to a conventional class C r.f. power stage, but differs in that the choke L_2 is included between the supply rail and the centre-tap on the tank circuit. This apparently simple addition profoundly alters the operation of the circuit, since the choke allows the voltage

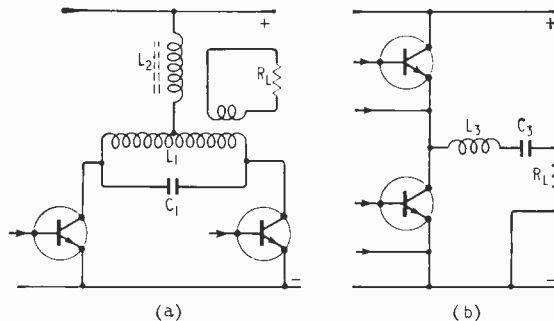

Fig. 1. (a) Current switching class D sine-wave amplifier. The inputs switch the transistors in push-pull with a 50:50 mark space ratio at required output frequency. R_L receives the sine wave power. (b) Voltage switching class D sine-wave amplifier.

of the tank to float freely up and down while imposing in exchange the restriction that the total current flowing from the supply rail must remain substantially constant. The switching of the transistors at their 50:50 duty-cycle thus results in an effective current source of high impedance forcing a square-wave of current through the tank circuit, since the transistors make the constant current flow to the two ends alternately. Such a square-wave is well known to contain sinusoidal (Fourier) components of current at all its odd harmonics, but as the load makes a significant voltage only at its resonant frequency, power is generated only at this one frequency and the harmonics are suppressed without any loss of efficiency.

The second arrangement, which is shown in its essentials at Fig. 1 (b) looks less like an r.f. power output stage and more like an audio circuit. Its working is closely analogous to that of its twin but with the roles of current and voltage reversed. Here the transistors switch the constant voltage from the power supply so as to form a low impedance square-wave voltage source, and the resonant filter $L_3 C_3$ ensures that only sinusoidal current of the desired frequency is delivered to the load. Again no power is generated at the unwanted harmonic frequencies and an efficient circuit is obtained.

To make a class D amplifier that is able to handle complex broad-band signals instead of steady sine-waves we modify the circuit of Fig. 1 (b) in two respects as illustrated in Fig. 2. First the switching action cannot any longer be a simple regular 50:50 waveform but must be made more complicated so that the voltage square-wave generated has the particular property that its frequency components within the band we wish to amplify correspond, as far as is practicable, with the signal being applied at the input. To do this a "carrier" at some relatively high frequency, say 100kc/s, must be generated within our circuit and must be modulated by the



K. C. Johnson, who has frequently contributed to *Wireless World* over the past twenty years, joined the computer department of Ferranti in Manchester in 1951 after studying at the University of Cambridge. When International Computers and Tabulators took over Ferranti's computer interests in 1963 he was transferred to I.C.T. Mr. Johnson is also a part-time lecturer in the Physics Department of the University of Manchester.

input in its mark-space ratio, and perhaps also in phase or frequency, to give a square-wave drive for the switching stage. Then, secondly, the filter arrangement must be modified so that current is passed to the load freely throughout the required band but prevented from flowing, if high efficiency is to be expected, at all other frequencies. Thus the tuned circuit L_{33} , C_{33} , is replaced by a top-cutting circuit in series with a d.c. blocking capacitor. The impedance of these components is low compared with the load and they no longer resonate in any practical sense. Over the past few years some unjustifiable claims have been made for the class D principle and it would be a good idea to pause and consider what we may hope to achieve from such a circuit before proceeding to a detailed design.

It would seem that the possible advantages may be considered under four distinct headings: Distortion, Tolerances and Temperature Stability, Power Economy, and Cost. Let us consider each of these aspects in turn and see what kind of an amplifier it is that we are going to be able to make.

DISTORTION

It must be clearly stated before we proceed further that there is no truth whatever in the idea that class D amplifiers offer an inherently lower level of distortion than the conventional class B type. If a circuit has no feedback, so that the input modulates a carrier and the resulting signal simply drives a switching stage after suitable amplification, then the familiar non-linearities and cross-over effects of the class B circuit are merely replaced by the less familiar troubles of preserving relative timings of the switching edges through the amplifier and of maintaining a constant amplitude for the square-wave at the output transistors. The quantities involved depend on roughly similar causes and their effects are approximately equivalent for a corresponding level of generosity in the design.

In practice a circuit of either type, which makes any serious claim to good quality, will scarcely fail to employ negative feedback. This reduces the effect of the distortions mentioned above by just the same mechanism in either kind of amplifier, but in the class D circuit the feedback will, of course, only be effective if it is made to act on the modulator system and to alter the timings of the edges as they are generated. The most straightforward way to obtain the required effect is by the arrangement shown in Fig. 3, suggested by the present author² and used also in the circuits of G. F. Turnbull and J. M. Townsend.^{3, 4} In this system the feedback itself causes the circuit to oscillate at the carrier frequency whilst also functioning in the usual way to reduce unwanted distortions at the output. With this arrangement there in fact no serious problem in increasing the sensitivity of the integrator amplifier A and the gain following it until the error in the feedback action, which can only be due to significant current and/or voltage swing at the input of this amplifier, is made of the order of, say, one part in a thousand. There will be little trouble from instability, and thus the class D principle appears to have an advantage in that almost unlimited overall feedback can be applied. It might be expected that this would enable a virtually distortionless circuit to be made, but unfortunately it doesn't work out like that. There is another form of distortion which the feedback is powerless to eliminate.

This results from the shortcomings of the modulation process itself, and the third article of this series will consider this problem in much more detail. Briefly, it

Fig. 2. The essentials of an a.f. class D output stage. The input transistors are switched in push-pull by a modulated carrier. L and C provide d.c. blocking and top cut passing only a.f. power to the load.

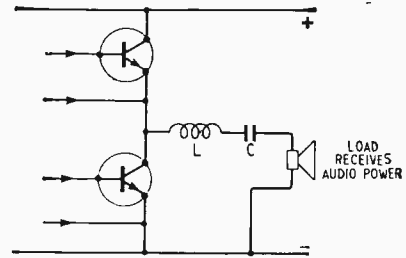

will be shown that it is in principle possible to modulate the edge-timings of a carrier square-wave so that it contains the correct frequency components throughout the frequency band from zero to just short of the carrier itself without the introduction of any harmonic or side-band distortions. In practice though the extra circuitry required to achieve even quite small improvements over the system shown in Fig. 3 seems likely to be more trouble than the advantages obtained can justify, and hence the circuit to be presented will continue to employ this simple system.

Three distinct kinds of distortion can arise in the modulation process and this feedback system suffers from all three. There is a boosting of the amplitude of high frequency components in the signal with respect to the lower ones, harmonic distortion occurs, and sidebands at sum and, particularly, at difference frequencies between the signal and the carrier are generated.

In the practical world we naturally wish to have the powerful output transistors switching only as fast as they must, since they will inevitably be either less efficient or more expensive if the rate is increased. But the boosting effect already mentioned takes the form of the addition of extra amplitude proportional to the square of the ratio of the modulation and carrier frequencies, so that it could be made negligible only by the use of an enormously high carrier frequency. In figures the boosting is just under 1%, if the ratio is 1 to 10, so that for distortions of this magnitude at modulation frequencies of 10 kc/s a carrier of 100 kc/s is required. Fortunately, this effect is independent of the signal amplitude so that it can be offset to a large extent by the characteristic of the filter network. The generation of third harmonic (there are no even harmonics as the system is balanced) also varies with the square of this frequency ratio and in addition the value as a percentage rises with the square of the signal amplitude. Its magnitude, however, is no worse than about 0.1% at frequencies where it can reach the ear even with a modulation amplitude of only 60% of the maximum, so that it is not so very serious but not entirely negligible, whilst the fifth and higher harmonics all have levels much lower than this and can safely be neglected. Thus we have found that even with a carrier at 100 kc/s, which is high enough to give considerable difficulty in obtaining suitable transistors for efficient switching, these distortion effects are comparatively serious.

Much worse though are the sideband effects since they are not on harmonic frequencies and so sound far more unpleasant at similar amplitudes. To make the best use of the transistors at the output stage we naturally wish to obtain as big a proportion of the switching voltage swing as possible as useful output amplitude, and this proportion is clearly the same as the greatest depth of mark-space modulation of the square-wave that we can manage. It turns out though that when a sine-wave modulation is applied which

makes the peak value of this modulation depth a mere 60% of the ultimate limit, the carrier sideband at the frequency ($f_c - 6f_m$) is already reaching 1% of the signal amplitude at frequencies which bring it within the audio band. Since the carrier frequency will itself have been reduced to about 80% of its original value by this amplitude of modulation, this occurs for modulation frequencies only a little greater than 10 kc/s with the proposed 100 kc/s for the unmodulated carrier. But the proportionate amplitude of this sideband increases as about the fifth power of the depth of the modulation (the absolute amplitude going with the sixth power), and the sidebands of higher order, which can more easily fall at low frequencies, rise even faster. Thus the quality degenerates rapidly with increasing modulation, particularly as audio signals are more complex than single sine-waves than that cross-modulation effects will inevitably be present as well. Therefore, although greater amplitudes of modulation can probably be used for the lower frequencies in the band the somewhat arbitrary figure of 60% will be assumed for the maximum acceptable depth when the simple system of Fig. 3 is used.

The class D system thus fails to earn full marks so far as distortion is concerned, and it seems likely that no economic switching circuit will ever be made to give an appreciably better performance. We have seen that figures in the region of 1% can be obtained only by the use of final transistors which are able to both switch very rapidly and carry almost twice the peak voltage that can be developed across the loudspeaker. The conventional circuits, on the other hand, can be made to give distortion levels approaching 0.1% without undue difficulty and without requiring such expensive transistors for the output stage.

The circuit to be described next month will make no claim, therefore, to compete with good class B designs in this respect. Nevertheless its performance may well be entirely comparable with that of the microphones, pickups and loudspeakers that must inevitably be included in any actual audio system, whilst judged by ear the quality is not obviously inferior. Thus these amplifiers may well find application among the vast range of jobs where distortion is not paramount if their other features give them an overall advantage.

COMPONENT TOLERANCES AND TEMPERATURE STABILITY

It is an unavoidable feature of any circuit using the class B principle that there must be a comparatively critical adjustment made in order to give the current level at which crossover occurs. If the value of this current is set too small the circuit distorts, whilst if it is too large power is wasted and the final transistors may overheat. No satisfactory circuit trick to determine this current adequately with normal tolerance components has ever been devised and it seems improbable that any ever will. Again any increase of temperature normally tends to make this current increase, so that the amplifier may distort on cold days or run away thermally after handling a particularly loud passage when it is hot. The critical nature of the circuit determining this current means that a comparatively expensive temperature compensation arrangement must be used, and, in order to fix the current accurately enough, most circuit designs include a component whose value must be adjusted experimentally, after assembly, so as to obtain a satisfactory crossover performance with the individual transistors actually used.

Furthermore it is common for these circuits to include

a second component whose value must also be adjusted on test to fix the average middle voltage of the series pair of output transistors. This second adjustment is not in fact essential and the necessary bias conditions could have been achieved automatically by the use of a few extra components of standard tolerance, but if the cross-over current must be adjusted anyway there is little pressure to eliminate this second adjustment.

The class D circuit has no cross-over problems, since at the mid-point both power transistors are still being driven to full cut-off and saturation and thus there is no critical current that must be adjusted. Accordingly it is worth taking the extra trouble to arrange for the mid-point voltage to be determined by a circuit that does not require close adjustment of component values and does not depend significantly on the characteristics of the semiconductor devices used. A bias arrangement of this type will be incorporated in the circuit to be described next month.

The class D principle has thus definitely scored here by eliminating both the critical adjustments and the need for the addition of extra components to give temperature compensation. This means that the switching type of circuit will be easier to design and manufacture, particularly if the demand is for large-scale production from cheap components or for construction as an integrated circuit where the tolerances must be large if a satisfactory yield is to be obtained.

POWER ECONOMY

Now it is in the matter of power economy that the class D system might be expected to show its greatest advantage, since this form of circuit has, in principle, an efficiency of 100% over the whole range of acceptable levels of signal, whilst neither of the alternative systems, classes A or B, can reach this figure at any level in handling sine-waves. It is particularly important to realise that class D retains its efficiency at lower amplitudes, since most audio amplifiers spend most of their working lives at signal levels of at least an order of magnitude below the maximum of which they are capable; the full power is required only for the occasional drum-beat or other loud transient. Thus the customary comparison of the efficiencies of different designs at the maximum amplitude is largely irrelevant to the reproduction of real music or speech and entirely so when the amplifier in question is a "baby-alarm" connected to a well-run nursery, for example! The important factors then are the efficiency at comparatively small amplitudes and the stand-by power consumed when there is no significant signal at all.

The efficiency of a class B circuit at these small amplitudes is relatively poor, being no better than the instantaneous signal amplitude as a percentage of the maximum, since all but that proportion of the supply voltage is dropped wastefully across the transistors. Class A has much lower efficiency still and is out of the running in this comparison so that the class D system has a clear advantage over both its rivals. The remaining question is whether it is possible to design a class D circuit that has a lower stand-by current than a class B amplifier of corresponding performance.

Consider two comparable amplifier circuits. The final transistors that each uses must be capable of delivering similar maximum currents to the loudspeakers. Their bases must therefore all receive similar peak currents from the driver stages, which must in turn be able to receive similar currents from the stages next earlier again and so on. The class B system has a slight ad-

vantage here perhaps in that the speed and voltage requirements are easier, so that both the final and the drive transistors may be expected to have somewhat higher current gains for similar expense giving reduced current requirements. Now both final and drive stages are normally made push-pull and worked in class B in a conventional amplifier of that type, so that in the no-signal state they take only the steady current required to overcome cross-over distortion. In addition to this the stage that precedes them must carry the steady current sufficient to drive them to the peak when required. Correspondingly the class D circuit will have its last two stages working in the switching mode, where they also lose some power even during no-signal conditions since they are being made to switch as rapidly as practicable to reduce the distortion effects. Here again the stage preceding them must carry a sufficient steady current to be able to drive them to their peak when necessary. The class D system in its turn has an advantage in that a more efficient "bootstrap" arrangement can be used, but essentially these currents all correspond fairly closely and there is no clear advantage to either system. The balance depends on the precise magnitudes of secondary factors like the current required to overcome cross-over distortion or the ability of the transistors to switch rapidly.

For a further reduction of the standing current, at the expense of a loss in output and efficiency at higher amplitudes, it might be possible to make the last three stages of a class D circuit all work in push-pull and so cut the power level of the earlier stages by a factor of ten or more. This possibility has not been followed up, but it might make a circuit with interesting properties, whereas the corresponding modifications in class B would probably lead to serious difficulties with both the cross-over current problem and instability in the feedback loop.

It does appear then that the class D system has an advantage over class B in its efficiency particularly at the middle levels of amplitude (where audio amplifiers usually work). This means in practice that no heat-sink arrangements are required for the transistors and that slightly simpler and cheaper power packs can be used for corresponding performance. Where mains power is used the saving in running cost, is of course, entirely negligible, but with batteries the difference could be important, particularly for "stand-by" applications, like the baby-alarm already mentioned, using circuits designed low standing current.

COST

The fourth direct comparison that can be made between the proposed class D circuit and conventional class B designs is of the cost and availability of the components required for corresponding performance. It seems here that, with the exception of the transistors for the final stage, there is little to choose between the two systems. The class D circuit may perhaps require a few more components for the same overall gain, if advantage is taken of the extra feedback that can be applied, but, apart from the points already mentioned there is no great difference in their cost.

Now it is true that the final power transistors of the class D circuit do not have to dissipate so much heat, due to the high efficiency of switching and this indeed means that heat-sinks need not be provided for them. It might perhaps be expected that the transistors themselves would also be cheaper on this account, but unfortunately this gain is more than offset by the severity

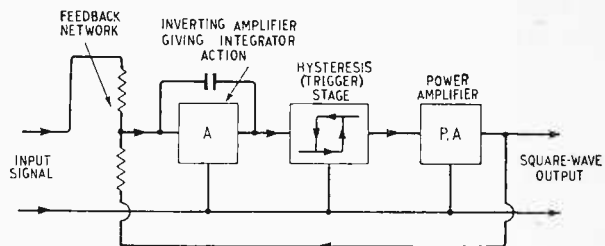

Fig. 3. The feedback type of square-wave modulator. The negative feedback causes the circuit to self-oscillate in such a way that the integrator error stays within the limits set by the hysteresis range.

of the other requirements. Satisfactory devices must not only be able to switch very much faster than the corresponding transistors in a class B circuit, but must also carry substantially greater reverse voltages, somewhat greater maximum currents and, worst of all, they must be able to withstand the application of the full voltage whilst the current is falling from almost the full value to zero without suffering avalanche breakdown.

In terms of figures the extra factor required in the speed is about a hundred times, since transistors with a cut-off frequency of 400 kc/s can follow an audio waveform in class B working and still have a reasonable margin in hand for stabilisation of the feedback loop, whilst 40 Mc/s is necessary to allow efficient square-wave switching at a carrier frequency of 100 kc/s. For the reverse voltage rating the corresponding factor is 1.7 owing to the need to keep the depth of mark-space modulation below 60% on account of the sideband distortion effects. An extra peak current capability of perhaps 1.2 times is needed to allow for the ripple current in the filter at the switching frequency when only a simple choke is used. Lastly the danger of avalanche breakdown at high currents adds a further factor to the voltage requirements, which may typically be of the order of two. This is due to the fact that transistors can normally stand a considerably greater voltage before breakdown when the current in them is small than they can when it is large; the effect has nothing to do with temperature but results from the concentration of the field into a smaller distance by the presence of the carriers in transit so that a smaller overall voltage can cause dangerous values to be reached.

There is a possibility that this avalanche trouble could perhaps be avoided by the addition of a suitable capacitance between the output point of the transistor switch and the power rails. The devices would thus see a capacitive rather than an inductive load for the first fraction of a microsecond as they switched, and would have a chance to be turned fully off before the voltage rose to dangerous levels. The snag here is that when in due course each transistor is turned on again the stored energy in such a capacitance is unavoidably converted to heat in the device, so that inefficiency of the worst kind is introduced. This effect is serious unless the cut-off frequency of the transistors is made substantially higher than the figure of 40 Mc/s already called for. At present this results in a greater increase of transistor cost than would have been needed for the corresponding increase of the avalanche breakdown voltage rating, and accordingly the possibility has not been explored further.

Fortunately there is no need for the customary careful matching of the current gains of the final transistors with the switching system. In exchange, though, it will be a good thing to take care to achieve a reasonable match in the switching speeds and saturation characteristics of both

the transistors and the circuitry in the push-pull channels, so as to avoid the generation of unnecessary second harmonic distortions which no amount of negative feedback can ever wholly eliminate.

In practice it turns out that the selection of a satisfactory type of transistor for this final power stage is not easy, and a glance at the type specified in the various published circuits indicates that this has been a common difficulty. There certainly have been germanium devices which met the requirements fairly well, but there is no readily available type that has a sufficient margin of safety to allow it to be recommended confidently for use in building an amplifier of real power. Accordingly we must turn to silicon and here we find a much brighter picture, though satisfactory devices are still by no means cheap and plentiful. Types are already available that can meet the requirements for useful output powers with safety, and the circuit to be presented is built round a pair of such transistors. The continual development of new semiconductor designs can be expected to bring improvements, and in particular those intended for television timebases and motor-car ignition systems will be suitable for these circuits since both these applications require tough devices that switch rapidly. They will also demand large-scale production so that reasonable prices can be expected.

It was mentioned earlier that there is a further possibility of saving cost in the construction of the power supply unit particularly when audio quality is not a paramount consideration. If an amplifier takes only a small standing current except when it is delivering a large power to the loudspeaker it may be acceptable for the smoothing of the supply voltage to be allowed to degenerate at the periods of heavy demand. This will cause some increase in the hum level at the output, but the amount need be only small if care is taken in the amplifier circuit design to prevent ripple on the supply rail from reaching the signal path.

The amplifier to be described was designed with this in mind and in fact gives a level of hum which is quite acceptable for most purposes when connected to a simple power supply containing no smoothing choke. Naturally the inclusion of a choke cannot but improve the performance, whilst even the use of a fully stabilized power source might presumably give a further slight improvement, though it is hardly to be recommended as the best place at which to spend extra money unless the rest of the equipment is incredibly good!

RADIATION AND STEREO PAIRS

A feature of class D amplifiers, which cannot really be used for a comparison because it is never likely to be anything but a disadvantage, is the possibility of their radiating interference to other circuits. This results from the large and rapid changes of voltage at the final stage. Moreover, as we have seen, these changes will only get larger and more rapid as better transistors allow improvements to be made in the efficiency and distortion performance. Needless to say this radiation must be limited as far as possible, by careful and compact laying out of the circuit, by the use of a good filter arrangement so that no avoidable high-frequency currents are allowed to reach either the loudspeaker leads or the power cable, and, if necessary, by screening as well. Apart from its general undesirability there is a particular need to keep the radiation level low if such amplifiers are required for use with radio receivers or in pairs for stereo reproduction.

The need in a radio receiver is surely self-evident, but

the problem with stereo is that when this simple feedback modulation system is used the carriers of the two amplifiers cannot be synchronized and "pulling" can occur. It has been reported that "loud beats" can be heard when a pair of class D circuits of this type are operated close together, and it has been implied that this is an aural effect which would be difficult to overcome. Observation, however, indicates that these beats are purely due to electronic interaction of the circuits and that they can be eliminated quite easily by ordinary care in the decoupling arrangements. When this is taken two such amplifiers can be used without any special problems and the loudspeakers located in any of the usual ways.

On balance the argument for making class D audio amplifiers rather than the conventional class B type is scarcely overwhelming. We have seen that if sideband distortion from the switching frequency is intolerable or if radio interference must be avoided at all costs then the conventional type of design will be used. If, on the other hand, the requirement is for the greatest economy of power or for the easiest component tolerances, the switching circuit can offer definite advantages. For any application there is little to choose between the two systems, but whereas the possibilities of the class B principle have been fairly thoroughly explored over the years, those of the switching system have not.

Thus it is the intrinsic interest of the idea which is the main incentive to this investigation and the possibility that applications of the principle may be important in other fields. The well known use of a high frequency "bias" current in the writing head of a tape recorder, for example, is essential because the writing process on the tape must be of a square-wave nature, whilst in the field of fluid-logic it seems very probable that the class D principle will have to be used to make any acceptable sort of high-power audio amplifier working with pneumatics. In cases of this nature it will be found that many of the basic features of this type of operation will be similar, and hence the experience that we are gaining will not be wasted even if transistor audio amplifiers of this type prove to be unattractive and never achieve any real importance.

REFERENCES

1. P. J. Baxandall, *Proc. I.E.E.* Vol. 106, Part B, 1959, p. 748.
2. Letter to the editor, K. C. Johnson, *Wireless World*, March 1963, page 135.
3. A. Feedback Pulse Width Modulated Audio Amplifier, G. F. Turnbull and J. M. Townsend, *Wireless World*, April 1965, page 160.
4. Efficiency Considerations in a Class D Amplifier, G. F. Turnbull and J. M. Townsend, *Wireless World*, April and May 1967.

Part 2 will give a practical 3-W audio amplifier design aimed at utilizing to the full the advantages of Class D.

Part 3 discusses in detail the distortions inherent in p.w.m. amplifiers.

VOLUME 73

From the March 1968 issue *Wireless World* will be printed by the offset litho process giving better reproduction. The size will be slightly larger (11 $\frac{1}{2}$ in \times 8 $\frac{1}{2}$ in), and to facilitate binding the present volume will continue until February.

MEASURING GRAMOPHONE PICKUP PERFORMANCE

By J. WALTON

A critique of some existing methods and a proposal for a fresh approach based on mechanical impedance

WHILE it may be helpful for the musical composer to consider "objective patterns" of musical composition, it must surely be conceded that musical appreciation in the last analysis is a subjective assessment. This is, of course, without belittling in any way either musical education or the cultural influences that have gone towards the creation of the subjective assessment. Similarly, while it is obviously the total subjective effect of the reproduced sound that is the ultimate requirement from gramophone reproduction, it must likewise be conceded that the subjective assessment of listening to recorded music is not sufficiently stable, precise or analytical to ever amount to more than a consensus of opinion which may or may not be reliably related to, for instance, factors of *pick-up* performance.

Of course, if one is not sure of the audible implications of measurements one might reasonably take refuge in "the listening test." And since it can be rightly argued that there is some doubt about the audible implications of some measurements, it is hardly surprising that a listening test has such prestige sometimes even in the most technical of circles.

Now while it would be presumptuous of me to believe I could dispel the above doubts, I do believe there are many aspects of measurement which can be so improved, or rather, better related to record reproduction as to remove any gross discrepancies between their results and those of the listening test.

In addition to considering the relation between listening and measurement, it is thus thought necessary to re-examine the better known measurements and see how they relate to pick-up performance peculiarities.

First of all, let me say that in giving measurements that are considered to relate to various audible phenomena from gramophone pick-ups, one assumes that proper tracking conditions have *already* been fulfilled. This is not as simple as it sounds, and it certainly sounds wrong in the listening test if ignored.

Unfortunately, this assumption of proper tracking is probably the most common cause of discrepancy between measured and audible results, and this has been forcibly brought home to myself and many others by the need for assessment of compatible mono pick-ups tracking stereo records.

TRACKABILITY

Since the articles on distortion in gramophone pick-ups that I shall later refer to, and the ensuing remarks on methods of measurement, all depend upon proper tracking, it is necessary to concentrate mainly upon this factor of "trackability" as the first essential in gramophone

pick-up performance. *All* other measurements (including that of frequency response) depend first of all upon proper tracking—that is, the continuous and consistent contact between stylus and groove wall without which no consistency of measurement can be obtained any more than if one tries to measure the performance of an audio amplifier when overloading it to, say, twice its rated maximum output! Whereas the last-mentioned condition may not even be possible, or may result in damage to certain transistor amplifiers, both pick-up and grooves are often run in overload conditions of several times this proportion. The fact that this mechanical recording system is so "flexible" and so robust has led to abuses that would not normally be tolerated on other parts of the audio chain.

Let us briefly consider the theoretical aspects of "trackability" before confusing the issue with practical details of actual measuring techniques. It will be assumed throughout that the reader is conversant with the three basic and relevant factors of motion, i.e. displacement, velocity and acceleration and that there are three corresponding factors of reaction to motion, i.e. compliance, resistance and inertia, and that their mathematical relationships are known and understood.

Now it has been common practice for pick-up manufacturers to quote "compliance" and "tracking weight" as the only factors worth mentioning in this relation to their pick-up specifications. The more technically serious manufacturers have also quoted stylus mass, though not all have used the same criterion for their figures—some say they have "calculated" it while a few have various and different ways of measuring it. And so it is also for "compliance." The figure quoted by manufacturers for tracking weight is usually the biggest laugh

The manuscript of this article was received in June 1967—ED.

John Walton, who is 47, has spent some 18 years in the recording industry and for the major part of this he has been concerned with pickup design and research into stylus-groove relations. After a few years in the radio industry he joined MSS Recording in 1945, Cosmocord in 1953 and Decca in 1959. For the past year or so he has been running his own business, Rainer-Walton Enterprises, producing the Walton M1 stereo-mono pickup.



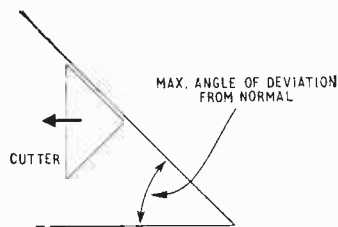

Fig. 1. Maximum recorded velocity is basically limited by the angle of the cutter rear facets and the groove speed.

of all as it could often be equally well guessed at by the pick-up user.

However, such manufacturers' figures are not really to the point. The point at issue here is what tracking weight is really required for proper groove contact with the *highest* recorded levels over the *whole* frequency range, and the factors of compliance and stylus mass—however measured—are only two of the three mechanical factors involved in the diagnosis of any mechanical system. Unfortunately, the third (omitted) factor—mechanical resistance—is the most predominant one in the majority of pick-ups. It may be said that this is not necessarily so in the magnetic pick-ups but it must be pointed out that any pick-up that does not have enough mechanical resistance is liable to have excessive lower and/or upper both output and mechanical impedance resonances at least, and be a less stable tracker on account thereof. Mechanical resistance, being the factor of damping, is the only known alternative to systems of decoupling (e.g. decoupled stylus¹) that can affect the otherwise inescapable upper (stylus-groove) and lower (arm) resonances. Lack of mechanical resistance is also involved in a tendency for the pick-up to bounce in the record groove at the slightest provocation from bouncy floors, rumbling motors or slightly wavy and eccentric discs, as well as on any occasion of mistracking.

It is therefore always necessary to consider mechanical resistance as at least an equally important factor as compliance and stylus mass in assessing this basic factor of pick-up performance—its trackability. Thus before considering methods of measuring compliance it is as well to bear in mind the limited usefulness of the figure at all.

Since the mechanical resistance, compliance and mass of a mechanical system together constitute its mechanical impedance,* it follows that the only all-embracing, and in fact at all correct and reliable, figures for trackability are the figures of mechanical impedance and that these will vary with frequency. It is therefore necessary in order to define a pick-up's trackability that a *curve* of impedance be presented from measurements taken over the whole range of audio frequencies in a similar way to that in which we present a frequency response curve. It might be said that the ear is more sensitive to inadequacies depicted in such a curve than it is to those variations in the frequency response curve on which we normally rely for first assessments.

*Just as the analogous R, C and L of an electrical system together constitute its electrical impedance. It is assumed that readers are familiar with the procedure of considering mechanical systems as electrical circuits.

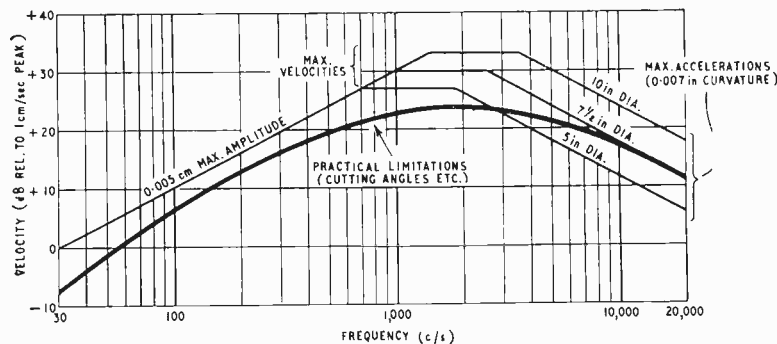

Fig. 2. Maximum recorded levels. Note that r.m.s. values are approximately 3dB lower.

Mechanical impedance curves.—To make a mechanical impedance curve it is necessary to have a record with suitable levels at all the frequencies required, and a light and properly pivoted and balanced pick-up arm^{2, 3}. Each frequency is played with the weight upon the pick-up head increased until proper stylus groove contact is obtained. To this end, a set of laboratory balance weights and an oscilloscope are also required.

Before describing further details of the method, it must be emphasized that the pick-up arm requirements are extremely stringent because tracking weights and variations thereof may be required to be as low as 0.1g, and few arms are capable of providing really consistent results because of excessive mass or erratic pivots. A force gauge capable of measuring 0.1g (in any direction) is a useful adjunct towards a first assessment of the latter. A very accurate rig (for lateral measurements) can otherwise be constructed using an odd gramme or so suspended on a 4- or 5-ft thread so that a measured movement of the upper end indicates a few milligrammes per inch before any movement of the lower end takes place.

Having found what is required for a pick-up arm to give consistent results, it will be discovered that, whereas mistracking at low and medium frequencies is readily detectable as a sharp dent or flat on the reproduced waveform, often the only noticeable change in high frequencies is one of output variation, normally just a rise then a fall in output as the tracking weight is reduced. The point of commencement of output rise will be the point to note. It can also be difficult to detect any substantial change where mechanical overload is already caused by too large a stylus radius. To this end the h.f. modulation *curvature* must be checked beforehand.

Thus, while it is essential to have a sufficiently high recorded level up to the high frequency region, in order to get sufficient and therefore measurable tracking weight, it is also essential to have sufficiently low modulation at high frequencies to avoid curvature overload on all normal stylus radii likely to be measured. This will also, incidentally, help reduce the damage caused to the test record by higher stylus-mass pick-ups⁴, which in itself is no mean aspect of the measurements. A convenient compromise has been found to be 5 cm/sec from 500 c/s to 10 kc/s and lower velocities elsewhere. The tracking weight figures so determined are then corrected to relate to say 1 cm/sec at all frequencies and plotted accordingly. One can thus construct curves showing the relative trackability of any pick-up.

When it comes to interpretation of these curves one must, of course, realize that while high mechanical impedances at the low and mid frequencies cause the

very coarse noises of mistracking, high impedances at the high frequency end cause general poor quality without obvious mistracking but with record damage instead. A consideration of these forces and the magnitude of the indent depths³ caused thereby in relation to the tiny amplitude of the recorded signals that have created them will indicate the importance of this. It will be seen therefrom that stylus mass (and above-mid-frequency mechanical resonances) are the only serious factors in record wear. The fact that high frequency record damage also implants harmonic distortion into the recorded modulation has been explained previously⁴.

Apart from the comparative value of impedance curves, they can also give quantitative measurements of practical pick-up tracking weights on commercial records.

Tracking requirements.—To assess tracking requirements one must know the maximum recorded velocities over the whole frequency range. This can be partly determined according to the possibilities presented by the record cutter, for with the almost inescapable cutter back-angles of 45° (see Fig. 1), the maximum recorded velocity is primarily limited to the groove speed. Such limitations alone would lead to very large amplitudes at low frequency and very high accelerations at high frequency. The low frequencies are therefore limited by amplitude considerations in relation to groove spacing and playing time. There is a general consensus of practice incorporated in the automatic devices that control their spacing that leads to a nominal maximum amplitude of 0.005cm.

Similarly, the general usage of 0.0007-in radius replay styli sets a limit on the maximum useful groove curvature that in turn should determine maximum cutter acceleration.

Further limitations on maximum velocity occur due to an effective increase in cutter back-angle under practical record cutting conditions (see below).

One can thus construct the curves of Fig. 2 which give the maximum usefully recorded levels over the whole frequency range. Using this curve in conjunction with pick-up impedance curves it is possible to determine the tracking weight required by any pick-up at any frequency.

This is the basic method of assessing the trackability

of a gramophone pick-up and since it has also been shown that mechanical impedance at high frequency^{5,6} can largely determine the quality of reproduction of a (correctly tracking) gramophone pick-up, the impedance curve is the most comprehensive "simple" assessment of a gramophone pick-up in general. Fig. 3 gives some typical examples of the relationship between impedance curves and distortion in the middle to high frequency region at levels well below any limiting factors.

The whole procedure would, however, make further demands on people in the gramophone industry whose jobs do not normally call for this level of technical knowledge. Some recent attempts to overcome this problem have been made under the term "trackability" and with the aid of a record giving maximum levels as it glides through all frequencies.

Supposing that instead of using a constant velocity recording one recorded the maximum levels at each frequency, one could then find the tracking weight required for each, and plot the curve of maximum tracking weights directly instead of going through the process of deriving the information from an impedance curve. And this curve of maximum required tracking weights is more readily understandable. The measurements are also easier to make since they do not usually involve the very small weights referred to above.

Unlike the impedance curve, however, this curve is dependent upon the maximum recorded levels used by the test record manufacturer. In the case of the above-mentioned gliding tone test record made by Dr. Dutton of E.M.I., I understand that the levels were determined by measurements on a wide selection of high level music recordings. The maximum amplitudes presented are in agreement with the experience of those who have made similar measurements, but are about half the value of those still generally quoted for maximum possible. A possible explanation of this discrepancy is as follows. Much of the work on the 15° vertical angle question still remains little publicised, and it is this work that uncovered such phenomena as master record groove and record cutter⁷ springback which made it necessary to move a cutter at one angle while its vertical orientation remained at another. Since this effect varies with frequency it means that the back angle of the cutter is effectively increased at some frequencies with resulting limitation⁸ on maximum recordable velocity.

Evidence from the electron micrographs of the grooves appears to confirm that there is some sort of limitation. Fig. 4 shows an effect apparently dependent upon cutting velocity, though on the leading rather than the trailing slope of the modulated groove wall. This effect is absent where velocities are such that the angle between the instantaneous direction of the modulation and the normal general direction of the groove is less than about 25°. The effect also seems to produce severe damage to the groove formation where this angle approaches about 40°. But until all the factors are calculable on different cutters, the practical measurement will probably be the best available guide as given on such a test record.

At the same time the maximum high frequency figures presented on this record are, while also in agreement with general experience, in excess of those that it is possible to trace with the 0.0007-in stylus. This record, therefore, is not only just unfair to the vast majority of pick-ups, but cannot always be used to discriminate between them in the high frequency region. (Since the same company appear to accept the standards of the recording-reproduction "correlators" (Dynagroove, etc.) that give optimum results for the 0.0007-in stylus, there seems to be some

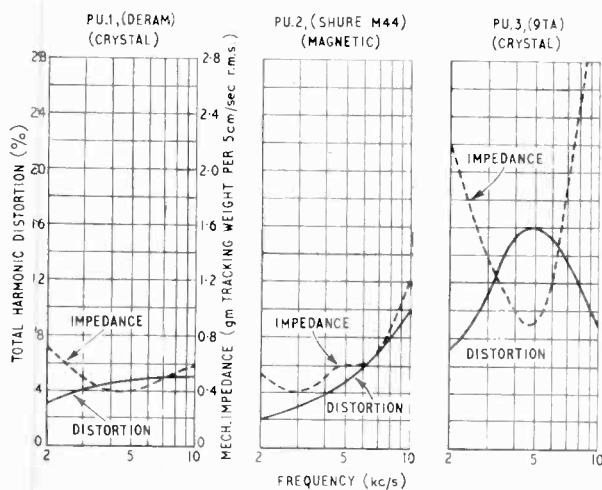

Fig. 3. Distortion and mechanical impedance (force/velocity) curves for three pick-ups, each with 0.0007-in radius styli, tracking 6 cm/sec r.m.s. at 7½-in dia.

inconsistency here.) The fact that some pick-ups with high tracking weights and 0.0007-in stylus radii will not always obviously audibly reproduce the distortion of this mistracking, may be considered to be irrelevant to our question of measurement since we must ensure that blame for the record damage that would thus be produced, and which may then be audible in another pick-up, is truly laid at the correct door.

It should not be difficult, however, to agree to some similar recorded curve as the basis for assessment of trackability of the majority of existing as well as future pick-ups without limiting the development of recording in any way.

Having done this (!) it is then necessary to consider the form that such a recording should take. The method of measurement on Dr. Dutton's gliding tone record is to

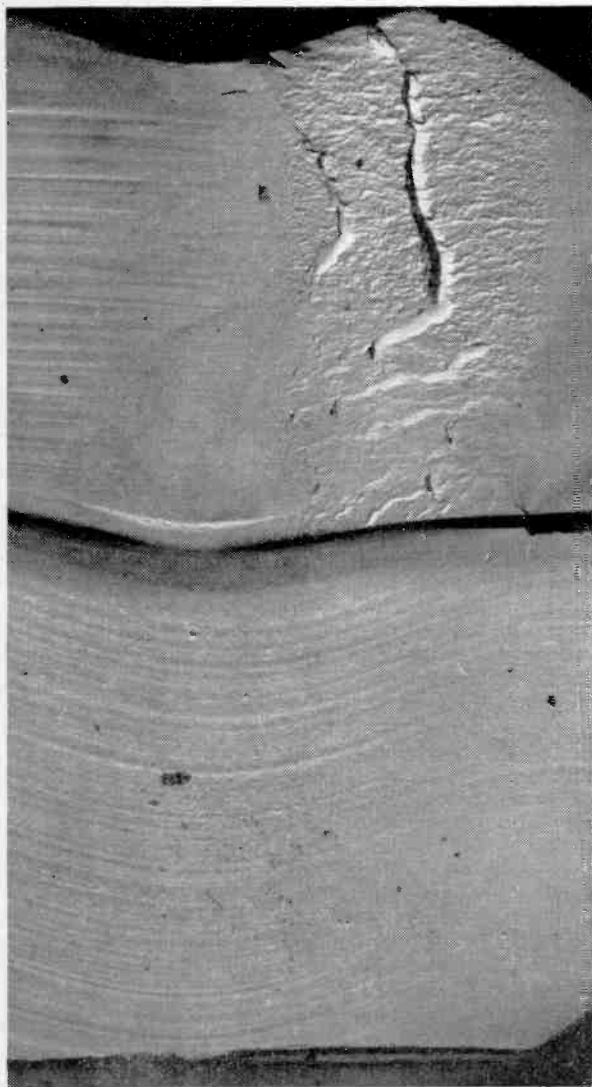

Fig. 4. Electron micrograph (by P. Chippindale, Salford University) of a record groove with blemish on leading face of wave at maximum velocity position. (This 4-kc/s left-channel tone of 1 cm/sec + 24dB has incidentally been played four times with the Walton M.1 mono pick-up, which accounts for some smoothing of the blemish on its lower half.)

either increase or reduce tracking weight until audible distortion occurs or just disappears, and then use this figure for tracking weight as the criterion of trackability. Apart from the difficulties (some as already mentioned) of such aural assessment of distortion from single tones at high frequencies, however, there is the necessity of playing all the tones at the maximum required tracking weight (as usually required in the 500 to 1,000 c/s region) and so causing even more destruction of the record in the high frequency end than would normally occur with the too high modulation it presents in this region.

While this record is the most widely useful tool to date for its purpose, it should also be considered in the light of what is required by the pick-up manufacturer if he is to be able to write down the results of his test in a manner more explicated of a pick-up's performance than merely the tracking weight it requires. Any further assessment than this would be better accommodated by a recording of similar levels but in fixed frequency bands, so that the tracking weight required at each frequency can be determined. The higher frequency ones that do not produce audible harmonic distortion but produce intermodulation effects under music conditions can then be assessed by oscilloscope and voltmeter (see under "Measurement").

When this is done one can produce comparative curves as shown in Fig. 5. It is hoped the ensuing arguments in this article will show that this is the simplest and most comprehensive form of pick-up assessment that can be made.

This, of course, is not the only relevant assessment of pick-up performance. And when this one has been made there remain both those tests concerned with finer or special aspects and those tests that are at present carried out instead of the impedance test. Let us consider the last-mentioned first.

MEASUREMENT OF MECHANICAL FACTORS

Compliance.—Before rushing in to measure compliance, it is as well to consider just what this quantity is. The only definition known to the author is that encompassed by the expression $C = x/P$, i.e., compliance, C , is simply the displacement x , caused by unit force, P .

The order of magnitude with which we are concerned, however, is that of micro-centimetres per dyne, so that microscopes with calibrated magnifications are required to detect the small displacement caused by the appropriate forces of the order of a gramme. This, perhaps, together with the fact that mechanical resistance grossly increases even the lower frequency impedance of a stylus, has led to methods of measurement known as methods of measuring "dynamic compliance" which not only reduce the measuring equipment to that of the usual electronics laboratory but also usually give lower figures for any given pick-up, and such lower figures are sometimes thought to include the resistive factor.

An example of the most common method is: one plays the pick-up on a record with appropriate low frequency tones and notes the frequency of the peak (f_{01}) of the pick-up's electrical output. One then adds known mass to the system and similarly finds its changed frequency of resonance (f_{02}). One then solves the simultaneous equation in f_0 with the original effective arm mass thus eliminated. In this way one finds a compliance figure from terms of frequency change for a given change of mass.

Now the very fact that this can give a much lower figure than the "static" method would indicate sufficient mechanical resistance somewhere in the system to seriously affect the quantities f_0 .

Even if it is argued that resistance should be thus included, it does not exonerate the method, because the ratio of compliance reaction to resistance reaction varies with frequency in the pick-up system, and also because the rate of variation with frequency differs between pick-ups.

It would seem therefore that this sort of method gives results that have neither absolute nor even comparative significance.

The simplicity and directness of the static method is unambiguous (see test procedures below) and the meaning of its results is correct according to the definition of compliance. As far as undamped magnetic pick-ups are concerned (i.e., those without the mechanical resistance factor), the results are valid (as also the dynamic method) for both comparative purposes and absolute measurement. Unfortunately, not only do we wish to compare undamped magnetics with those that do have some damping but also with (and make comparisons between) piezo-electric pick-ups where mechanical resistance can (and often does) predominate for all but the most extreme bass frequencies.

It would appear therefore that compliance figures are now generally meaningless and should cease to be used as assessing criteria. It is interesting to calculate that a compliance of 1×10^{-6} cm/dyne is sufficient to track the maximum amplitude of 0.003 cm at 3 grammes. Since most modern pick-ups have compliances of at least several times this value, and/or need much higher tracking weights, the argument that compliance measurement is now irrelevant is thereby enhanced.

For those who still insist upon compliance figures, however, one may as well use a method that is most easily and most accurately accomplished. In one such method the pick-up is mounted in an arm with its stylus resting in a stationary record groove and is subjected to the required tracking weight. A force of about half the tracking weight is applied first to one side and then to the other and the deflection of a line fixed to the pick-up directly over the stylus is measured by a microscope. Compliance is then given by total distance divided by total force. Pick-ups with any appreciable mechanical resistance should have, say, 50% overload on the applied force for a few seconds directly before measuring the deflection in each direction in order to bring the deflection quickly to its maximum.

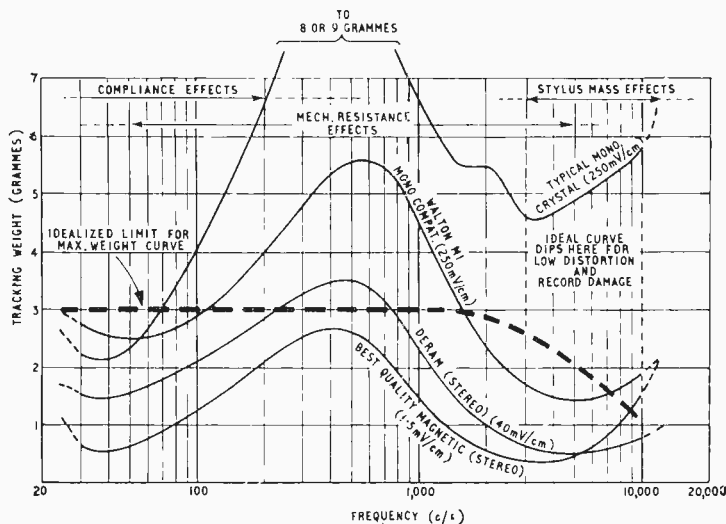
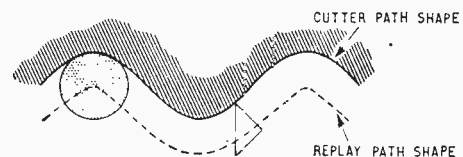

Fig. 5. Tracking ability. Tracking weights for maximum levels of Fig. 2.

Fig. 6. Showing how tracing distortion is caused by a spherical replay tip tracing a groove made by a sharp-edged cutter.



SYMBOLS USED IN TEXT

C	= compliance.
D_2	= 2nd harmonic distortion fraction.
f	= frequency in c/s.
M	= stylus mass.
P	= force.
r	= stylus radius.
V	= recorded velocity in cm/sec.
V_{gr}	= groove speed in cm/sec.
W	= tracking weight.
x	= displacement.
η_{III}	= stylus mass distortion fraction (2nd harmonic).
θ	= tracking angle error in degrees.

Let us now consider the other factor, stylus mass. Again, there are different methods of measurement which lead to different answers. The choice, however, is not so simple as that in the case of compliance.

Stylus mass.—Basically there are three methods of measuring stylus mass. One is a measurement of the upper resonant frequency—the stylus groove resonance—from which mass is deduced from $f_0 = 1/(2\pi\sqrt{MC})$ where C is the compliance of the contact between stylus and groove.

Another is the "free resonance method" in which the resonance between stylus mass and pick-up compliance is measured by driving the pick-up from an oscillator and observing the stylus resonance under a microscope. Again $f_0 = 1/(2\pi\sqrt{MC})$ where C is the pick-up compliance.

The third method is that of finding the stylus reaction to a known acceleration by increasing the tracking weight till the pick-up correctly reproduces a known acceleration due to a high frequency modulation of the groove.

Briefly, the first (upper resonance) method suffers from a host of more or less minor variables in the factors of stylus radius, Young's modulus and temperature effects in the record material, and tracking weight and mechanical resistance somewhere in the pick-up. Last but not least is record material resistance, particularly in plastic deformation of the record groove. This last-mentioned factor in particular is not well determined or well con-

trolled; another objection to the method is that it neither detects the effects of resonating stylus arms, etc., nor gives answers on distributed mass systems and completely falls down on the "decoupled stylus" system.

However, since this method is in use and gives a concise answer it is not without significance and it will be as well to indicate a preferred procedure.

To cover the widest number of cases in the least indeterminate manner one can best use a new white noise record and a panoramic display analyser. Procedures with frequency records and voltmeters are often extremely trying with waverings that are sometimes many times the size of the peak one is trying to find, or consequently misses.

Having found f_0 , one equates this to $1/(2\pi\sqrt{MC})$ where C is the value of the stylus-groove compliance.

The second method (free resonance) does not seem to suffer from so many variables, but like the first method falls down on distributed mass systems and is very difficult to perform on well damped pick-ups. A tiny speck of light on the stylus is observed under a microscope and the driving oscillator frequency is varied until the spot becomes slightly elongated. This elongation is too minute to detect on most piezo-electric pick-ups.

The third method suffers from the fact that it does not necessarily measure stylus mass alone but also may include some resistive element. Now while the resonance method for measuring stylus or pick-up compliance is invalidated partly due to the intervention of resistance sometimes irrelevantly affecting f_0 , and the upper resonance determination in measuring stylus mass is likewise made less sure by resistive effects in the groove, the resistive effects in the case of the stylus reaction method are those directly affecting pick-up tracking weight in the same manner that they affect the measurement to be made. Just as one octave variation of frequency will not over seriously alter the intrinsic value of resistance at low frequency, neither is it likely to do so at high frequency where the requisite smooth curve (see "(b)" below) exists. But whereas the latter octaves cover the whole range from, say, 5 kc/s to 20 kc/s, the former merely covers, say, 8 c/s to 32 c/s.

The worst things about this method are (a) that ex-

perience of pick-up tracking behaviour at h.f. is required of the tester (see under "Impedance Curves") and (b) that unless a smooth straight curve is obtained for a sufficient stretch around the frequency of measurement, i.e. somewhere prior to the upper resonance, the answer once again can be very misleading. This requirement therefore includes that an impedance curve be plotted for the region first, and this really makes its use superfluous.

One must conclude from the above three items that the mechanical impedance curve must supersede the other measurements mentioned in all pick-up performance assessments. Or, if agreement could be reached upon maximum recorded levels, it would be easier to use the curves of maximum tracking weights required.

MEASUREMENT OF DISTORTION

Having got the above tracking factors in apple-pie order(!) the worst, and sometimes the only obviously audible, distortions are thereby eliminated. Then and only then is it possible to make any stable general comparison between pick-ups with regard to their ability to faithfully reproduce the recorded sound.

Since this article is concerned with measurement it will not be considered necessary to more than briefly mention the sources of distortion which are described in the literature, namely:—

1. Tracing distortion¹⁰ which is due to the geometric anomalies caused by a spherical replay tip in tracing a groove modulated by a sharp-edged cutter (Fig. 6).
2. Stylus mass distortion¹¹ which is due to the non-linear deformation of the record groove by the mass inertia of the stylus.
3. Comparatively minor sources of distortion—the most important of which is that of tracking error, that geometric type of distortion due to the replay stylus moving in a different plane to that of the cutter's motion.

The effects of all three distortions have been described in terms of harmonic production, intermodulation production and phase modulation, and it has been shown^{6, 16} how all three methods are directly related ways of measuring the same phenomena in gramophone reproduction. Either one is a measure of the other, so that regardless of which form of distortion is the most objectionable to the ear, all three methods (used correctly) are valid interpretations of the same effects. The approximate expression,¹⁰ for instance, for tracing dis-

tortion harmonics at 400 c/s is $\frac{400\pi V_r}{V_{gr}^2}$ and that for the

i.m. products by the 400-4,000 c/s S.M.P.T.E. method is $\frac{8,000\pi V_r}{V_{gr}^2}$ showing only a difference of magnitude but

the same law. And since phase changes of over 1 radian do not occur (normally) in gramophone tracing errors, the frequency modulation products can be shown to make no effect on the above figures.

It is also true that measurements (as opposed to calculations) of distortion do not normally distinguish between the forms of distortion (tracing, tracking or deformation) but measure the total combined effect of the above distortions. On the other hand, compared with the small tracking error distortions that do not vary with frequency ($D_s = 1.75 V_h/V_{gr}$) and are thus just as large at low frequencies as high, the tracing error distortions vary with frequency ($D_t = \pi V_r f/V_{gr}^2$)¹⁰ and thus only begin to swamp the effect of tracking error distortion at about 700 or 800 c/s. Thus a measurement taken at

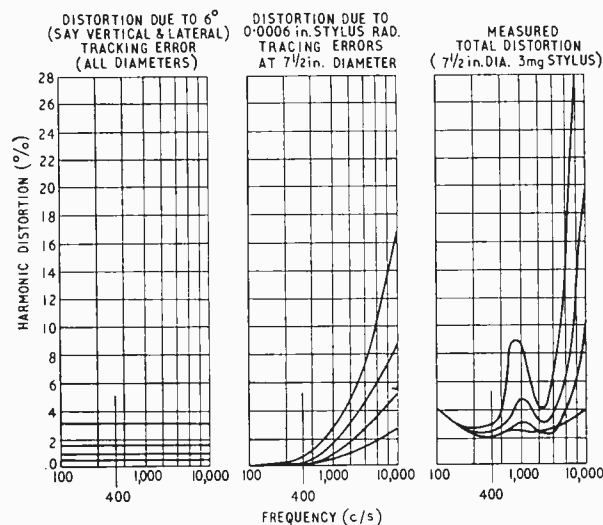

Fig. 7. Complex variation of distortion with frequency invalidates 400-c/s S.M.P.T.E. intermodulation measurements on gramophone pick-ups.

40Gc/s will be largely one depending upon the generally small factor of tracking error, whereas a measurement at 1,000 c/s will be more dependent upon tracing error.

I have deliberately not said "over" 1,000 c/s for the stylus mass distortion varies as the square of frequency ($v_m = KVM^2f^2W^{-3}r^{-1.3}$)¹¹ and its influence will begin to predominate in many pick-ups from about 3,000 c/s upwards.

To illustrate these points further, Fig. 7 shows curves for (1) tracking error (calculated), (2) tracing error (calculated) and (3) the total measured distortion for the same pick-up. An explanation of, for example, the cancellation effects which cause a dip in the last-mentioned are to be found in the author's articles on stylus mass and distortion.¹⁶

It has been necessary to consider *what* distortions occur in order to determine the method of measurement. Because of the complicated way in which the various distortions vary with frequency, any measurements of distortion taken at one or two frequencies are unlikely to be of any value.

For instance, intermodulation distortion from a 400—4,000 c/s tone is a measurement of the effect of the large-amplitude 400-c/s tone upon the stylus when tracing the 4,000-c/s tone of 1/40 its amplitude. The sidebands measured at 4,400 c/s, etc., are thus merely products given by any inability of the pick-up to faithfully trace or track the single 400-c/s tone. The 4,000-c/s tone in effect is mainly an indicator tone.

Thus the very common practice of quoting an i.m. figure on this basis is often a measure of the minor distortion of (probably vertical) tracking error and bears little or no relation to the major distortions of gramophone reproduction. In fact, a 400-4000 c/s record has been used for the purpose of measuring vertical tracking angles!¹²

Again, internal distortions from pick-ups and their transducing systems are normally minute, but can be smaller or greater regardless of the overall quality of the pick-up. It would thus be possible by using well set up pick-ups under tests similar to the above, to falsely show, for instance, that many cheap and nasty crystal pick-ups were better than some excellent expensive magnetics.

Thus if the intermodulation method of measuring distortion is to be used it must obviously be adapted to produce a distortion/frequency curve again as with the impedance and the output curves. The above mentioned widely spaced frequency (S.M.P.T.E.) method is obviously unsuitable since it cannot be used to measure at high frequencies.

The alternative method is the close frequency (C.C.I.F.) method and again this must be adapted appropriately to the gramophone. This method would use signals of equal amplitude at, say, 4,000 and 4,400 c/s, and one would measure the 400-c/s product as the criterion of distortion production. Unfortunately the sensitivity of this method is dependent upon the separation between the two frequencies, and in order to keep it constant over a suitable range of frequencies of measurement, the separation must be a constant proportion of the mean frequencies of the two modulating tones. One is thus presented with the problem of constructing different filters for each frequency of measurement, or else of having inadequate sensitivity at high frequency. Again, the use of a panoramic display analyser seems to be the neatest solution, and the author would very much like to see the development of a suitable disc at near max. levels.

In the meantime it would appear that discs with

suitably recorded high level single frequency bands offer the most realistic approach in distortion measurement using harmonic products as the criteria—displayed upon a panoramic analyser.

If the fixed-tone-band maximum level disc referred to under the heading of "Trackability Measurements" were further modified to be, say, 6dB lower level all round, such a disc could possibly be made to serve the two purposes of measuring both trackability and distortion. The lower level would also make the disc more durable in its probably more common use for trackability assessment.

Such methods have been used in the assessment of elliptical styli¹³, the effect of stylus mass⁴ and unpublished measurements of recording-replay correlators, and have been found to relate in general to the corresponding mechanical impedance curves of the pick-ups used, together with a knowledge of the stylus radius.

Until such discs are generally available, however, or preferably the above-mentioned proportionate close-frequency disc is developed, it would appear that the mechanical impedance curve method is the best possible assessment and a "maximum level" disc would be the easiest method if anomalies mentioned can be avoided.

Future experiments on distortion measurement should seriously consider "proportionately spaced" close frequency i.m. tests at about 6dB below the maximum levels, or similar level noise spectra with measurements in stop bands¹⁷. A noise disc with white noise preferably modified to the maximum velocity/frequency curve and with one, two or more precise frequency bands omitted (stop bands) could be used in conjunction with one, two or more (accordingly) sharp filters in the reproduction chain to assess both harmonic (from low frequencies) and intermodulation products (from high frequencies) of the multi-frequency region provided by the noise spectrum. Some work would be needed to determine whether more than one or maybe two stop bands would be required, to give an overall pick-up performance assessment.

OTHER MEASUREMENTS

Frequency response.—The measurements most commonly made are those of frequency response and separation. It should not be necessary to say a great deal about these. There are, however, certain reservations.

Frequency response test records are usually made with the high frequencies on the outside diameter of a 12-in 33½ r.p.m. record, and since the recording engineer has no control over tracking weights, stylus radius or stylus mass, he cannot (at least accurately) correct for the effects of scanning loss^{18, 2} and translation loss^{19, 2}, both of which affect the high frequency response of a pick-up as it tracks from outside to inside of the record.

Since the low frequency response of a pick-up is governed by combined mass of head and arm, quite different bass responses will be obtained according to the effective mass of the pick-up arm.

One must therefore realise that frequency response measurements follow a convention which does not automatically take care of changes due to tracking weight, stylus radius, etc., and in which the necessary conditions for bass response are not defined.

Since it can be demonstrated that 1 decibel is the smallest discernible difference between two sound levels, and since concert halls, studios, and living rooms—even when acoustically good—have effects which amount to several times this ratio, as also do the above variable playback losses, it is clear we need not compare frequency response curves for every decibel of variation like an exercise in "one-up-manship." The worst effects of poor

frequency response are often more related to corresponding effects in the mechanical impedance curves.

Finally, it is no use testing a pick-up for anything at all unless all the factors of equalization are sufficiently understood to enable one to avoid the pitfalls of following the amplifier manufacturer's incorrect advice to the effect that "feeding a crystal pick-up into 50,000 ohms will correct it to velocity characteristic." 10,000! would be a safer figure, and even then the better (flatter response) pick-ups would need a special equaliser for removing some of their inbuilt correction for discrepancy between "constant amplitude" and R.I.A.A. recording characteristics, before feeding into "magnetic inputs."

Separation.—The remarks about response curves also apply to separation curves, but much greater variations occur in this case.

The author has not found any simple means of measuring separation at low frequencies without cumbersome correction figures, because of the amount of rumble that normally exists in the best of turntables (and sometimes on the record too). To this end, the principle of using an arm of low vertical inertia^{11, 12} has also been found to be of the greatest assistance as it has been also in the case of all the other measurements.

Rumble thus necessitates that one always measures separation with attenuation of all frequencies below 500 c/s, and corrects bass readings accordingly. While much concern is often shown for the separation curve, it should be realized that a pick-up separation may either increase or decrease with increase of recorded level and unless measurements covered both high and low levels the results may only be valid for that normally moderately low level associated with 1 cm/sec at 1 kc/s.

It is also true that considerable differences—again factors of over 2:1—exist between separation curves taken on records made on different cutters. This would be very frustrating for the pick-up designer if it were not for the fact that the hi-fi enthusiast in any case expects a separation curve that is far more than adequate for the home and thus no one hears the slightest difference on account of it.

Tracking Error.—Lateral tracking angle measurement is very simply accomplished by Percy Wilson's special protractor made by J.B. Some very high compliance pick-ups, however, may have one or two degrees skewing of the stylus arm if used without any side-thrust correction, and this may invalidate careful setting since this skewing does not show on the head.

Vertical tracking angle measurement, however, needs more sophisticated apparatus for even the simplest measurement. Woodward and Cooper^{11, 12} have shown that simple deflection of the stylus is misleading and that the only valid criterion is the frequency intermodulation products from the sort of tone previously used for general distortion assessment. (The a.m. products, while still indicating mainly the tracking error, did so with anomalies.) A special record was produced with the bands of tone made with various cutting angles so that the band that gave least f.i.m. products for a particular pick-up denoted the angle. This still (as was admitted) left the question of vertical angle undecided at higher frequencies where the system would presumably not work because of interference from tracing and stylus mass distortion. It must be said (from experience) that on vibrating systems such as a gramophone pick-up stylus, it cannot be assumed that angles of motion remain constant at all frequencies. It is also likely that discrepancies of tracking angles do in general not give a significant proportion of total distortion effects.

Square wave tests.—Last and probably least is that old friend (or bogey) the square wave test. If ever a test were both comprehensive and misusable it is this. It is not sufficiently analytical, however, even with use of troublesome precautions) to be of much use to the pick-up designer, and for similar reasons, therefore, should be treated with circumspection by pick-up users¹³.

It would thus appear that there is no measurement on the gramophone pick-up that can be made without its having serious limitations, raising difficulties in getting the necessary records, etc., or else is of no real significance. If the opening remarks to these articles are considered, neither can it be claimed that there is any solution to these difficulties in "the listening test" which even at best cannot be considered to fall within the category of objective quantitative measurement.

Those who must make comparative measurements on gramophone pick-ups and who must be able to publish results, can only consider the above difficulties as obstacles to be surmounted both by some standardisation of test procedures (by appropriate bodies) after consideration of all the information and by the commercial production of suitable test records, etc., to make these procedures generally available.

To this end, the above information is offered as a minimum basis.

CONCLUSIONS

1. The commonly quoted 400-4000 c/s intermodulation distortion test figure is irrelevant to the general performance of a gramophone pick-up*.
2. Similarly, figures for pick-up compliance, even if obtained by standardized methods, can be misleading even concerning tracking weight.
3. Different methods of measuring stylus mass are not easy to correlate.
4. The best criterion of all round pick-up performance would be most readily gained from the mechanical impedance curve—together, preferably, with an agreed standard on maximum usefully recorded levels, in order to produce a curve of "trackability."
5. All distortion tests should have regard to test record damage by stylus mass.

REFERENCES

1. (a) British Patents 979856/857/858/859/860. Foreign patents pending.
(b) "The decoupled stylus tip," J. Walton. *Hi-Fi News*, March 1956.
2. "Pick-ups, the key to hi-fi," by J. Walton. Pitman, London (1965).
3. "Pick-up arm design," by J. Walton. *Wireless World*, June 1959.
4. "Stylus mass and distortion," by J. Walton. *J.A.E.S.*, April 1963. *Wireless World*, April 1963.
5. "Gramophone record deformation," by J. Walton. *Wireless World*, July 1961.
6. "Stylus mass and elliptical points," by J. Walton. *J.A.E.S.*, April 1956.
7. "The vertical tracking angle problem in stereo record reproduction," by B. Bauer (C.B.S.). I.E.E.E. meeting, February 1963.
8. "Further thoughts on geometric conditions in the cutting and playing of stereo discs," by Bastiaans (Philips). *J.A.E.S.*, January 1963.
9. "The rational design of phonograph pick-ups," by F. V. Hunt. *J.A.E.S.*, October 1962.
10. "A theory of tracing distortion in sound reproduction from phonograph records," by Lewis and Hunt. *J.A.S.A.*, January 1941.
11. "Tracing distortion in stereophonic disc recording," by Corrington and Murakami. *R.C.A. Review*, June 1958.
12. "Reproduction distortion in stereophonic disc recording," by N. O. G. Shiga. *J. Japan A.E.S.*, Vol. 18, No. 1, 1962.
13. "Vertical tracking angle errors in stereodisc systems," by Halter and Woodward. *J.A.E.S.*, January 1964.
14. "P.U. arms and turntable rumble," by J. Walton. *Wireless World*, Sept. 1962.
15. "Techniques for measuring the vertical tracking angle of stereo phonograph pick-ups," by J. G. Woodward. *J.A.E.S.*, July 1965.
16. "On tracking and tracing error measurements," by Cooper. *J.A.E.S.*, October 1964.
17. "Pick-ups and distortion," by J. Walton. *Hi-Fi News*, June and July 1966.
18. "A program distortion monitor," by J. H. Dessen. *J.A.E.S.*, October, 1965.

*Alternative suggestions are offered in the article.

Air Traffic Control Centre for Southern England

THE new Air Traffic Control Centre to be located at West Drayton will be built under contracts valued at £2.75m, and is expected to become operational, progressively from mid-1969, progressively that is, until it has within its jurisdiction, the whole of the en-route air space for the southern half of the United Kingdom. The Board of Trade state that "advantage is being taken of all available means of improving the efficiency and safety of the en-route air traffic service by the introduction of new techniques (for example, the automatic processing of A.T.C. data), the better exploitation of existing or emerging systems (the secondary surveillance radar system) and better systems integration and data interchange between air traffic controllers carrying out related functions or responsible for aircraft in adjacent parts of the total airspace."

The National Air Traffic Control Service has now placed contracts with Plessey Radar for a bright display system, with upwards of 40 scan converters, and for an s.s.r. plot extraction and display drive system, extracting data at five remote stations and feeding West Drayton via narrow band radio links and/or line channels.

The Plessey radar system enables coded identity and height information from each aircraft in the operational area to be received and automatically decoded for onward transmission over telephone lines to the control centre. Here the relevant flight data and tracks are presented on Plessey Digitrace bright daylight viewing displays at the control consoles. The advantages of this are that the controller's work load is reduced by automating many of the functions at present carried out by manual operation, and the working environment is improved by allowing operation in normal daylight conditions. The secondary surveillance radar, now coming into significant use throughout the world, and already a mandatory system in many countries can offer facilities to the radar controller which he can get in no other way. Unlike primary radar which is a passive system, s.s.r. is an active system requiring a transponder to be carried in each aircraft. This automatically replies to a pair of pulses transmitted from a ground based interrogator/responder.

The transponder sends a train of pulses which are received by the interrogator/responder. Since the transponders are transmitters, the reply is transmitted at full strength regardless of the distance between ground station and aircraft. In this way the s.s.r. system can determine and display the position of each fitted aircraft, provide identity data in the form of allotted code number, height data (when the aircraft is fitted with height telemetry equipment), and the means of associating this data with the aircraft echo or position on the radar display.

The decoding and display of data received from aircraft requires a system that ensures that all the information will not only be received and processed but also displayed. The Digitrace bright display technique avoids the fast "fly back" of normal television systems by employing a digital raster system. This scan can be halted at random, enabling characters to be written on the display at any time, without loss of radar information. The actual plot extractor to be used takes the pulses from the aircraft via the interrogator apparatus and produces a message in digital form. This message from an aircraft may contain azimuth, range, identity, height, special position information (SPI) pulse present/absent, civil emergency code present/absent, military emergency code present/absent, and civil radio present/absent. The controller's console has selectors incorporated to enable the relevant data only to be displayed; since not all data on each aircraft is required continuously.

To ensure that future staff requirements will be met for the telecommunications branch of the National Air Traffic Control Services a new apprenticeship scheme has been started. The Civil Aviation Signals Training Establishment (Board of Trade) has initiated this scheme at Bletchley, Bucks. Here an annual intake of 30 apprentice technicians will be trained over three years in practical electronics and techniques employed in aviation ground equipment, as well as studying for an O.N.C. in engineering. The last fifteen months of the course will be served at various airports and air traffic control centres, obtaining practical experience in maintaining the operational services.

Mobile Educational Television Studio

A SELF-CONTAINED, comprehensive mobile television unit for producing live or recorded educational programmes has been designed by the Marconi Company, of Chelmsford, Essex. There are three cameras, a video tape recorder, "preview" and "on air" monitors, synchronizing pulse generators, and pulse and vision distributing equipment. There is a programme sound system which includes a six-channel sound mixer. Each of the three cameramen is provided with a headset consisting of headphones and an integral boom microphone. The microphone and left earpiece provide two-way communication between the cameraman and production staff in the vehicle, while the right earpiece provides him with the programme sound. Picture monitors are two 23-in sets with forward facing speakers. This equipment fitted into a van is intended for use by education authorities, and will provide a means of recording educational programmes for later transmission through a c.c.t.v. network. Alternatively, it can be driven into a school, and with the two monitors provided, produce a lesson on the spot.

Programmes are controlled from the van, but all portable equipment is stored in special compartments within the vehicle, leaving room for up to five persons to travel in comfort.



Satellite Communication Seminar

"COMMUNICATION-satellite earth stations" is the theme for an international seminar being organized jointly by the Post Office, Ministry of Technology, and British industry for next year. The major part of this seminar (May 20-31, Royal Lancaster Hotel, London) will deal with the type of station designed for the Intelsat Global Communication System, but papers will also be presented on small earth stations and other specialized aspects of satellite communications. The first week of this seminar is allocated to the reading of papers, and they are expected to be of interest to overseas administrators concerned with the planning, specification, purchasing and operation of earth stations. Technical and financial questions, operating procedures, training and maintenance will be discussed. The second week will be taken up with visits to the P.O. earth station at Goonhilly, and to important scientific and industrial establishments engaged on work in the field of satellite communications. A number of overseas countries will be invited to participate, and observers from British industry and other interested U.K. organizations will also be invited to attend.

Satellite Solar Studies

THE Orbiting Solar Observatory OSO-D satellite launched by N.A.S.A. from Cape Kennedy on the 18th October is reported to be orbiting successfully, and that good results are being obtained from it. Of the nine experiments carried on board, seven are for American research laboratories, and two are based upon instruments designed at University College, London, and Leicester University, and financed by the Science Research Council. The first of these two experiments uses a broadband solar x-ray detector which is designed to detect solar x-rays in the region of 1 to 20 Å and 44-60 Å. The measurements may lead to a method of providing an early warning of energetic particle fluxes from large solar flares which are hazardous to high flying aircraft and manned operations in space. The second experiment, based on an ultra-violet monochromator devised at the Mullard Space Science Laboratory of University College, will monitor the total fluxes of helium II radiation at 304 Å and hydrogen Lyman-Alpha radiation at 1216 Å. The information from this experiment sent back to earth will indicate how changes in the Sun's helium radiation affects the Earth's ionosphere.



The BBC introduced this hand-held colour TV camera at Twickenham recently. This new camera from Peto Scott of Weybridge has been developed for sports and other events where easy mobility and flexibility are needed. Its basic electronics are the same as in regular broadcast cameras. The BBC used it to transmit live in black and last Saturday to record in colour for later transmission.

Medical electronics is the subject of the 1967-68 Faraday Lecture, which is being given by Dr. D. W. Hill, senior lecturer in medical physics in the Research Department of Anaesthetics of the Royal College of Surgeons. This lecture, the 39th in the series arranged by the I.E.E., starts with a brief history of early medical experiments with electrostatic apparatus, and then moves on to electronic techniques for foetal and neonate studies. Electronics for cardiac control, measurement, and surgery, will be emphasised through a short film on cardiac surgery. Other aspects of medical electronics discussed are intensive care, analogue and digital techniques, and device implantation. Dr. Hill's lecture tour started in Cardiff on 14th November, and it will finish in Belfast on 26th April. The London venue is the Central Hall, Westminster, S.W.1, at 6 p.m. on 30th November (general public) and 1st December (students).

Continuously tunable optical radiation in the 0.5 to 0.8 μm wavelength range (blue-green to red light) has been produced by the Quantum Physics Division of S.R.D.E. The discovery offers a method of filling in the gaps in the spectrum where laser frequencies do not occur and may have applications in optical communications. The radiation is generated by passing the light from a Q-switched (pulsed) neodymium laser through a crystal of lithium niobate, and the frequency of the resulting narrow band e.m. energy can be varied by adjusting the temperature of the crystal (typically between -100°C and $+400^\circ\text{C}$). S.R.D.E. suggest that the radiation can be explained as the result of a frequency up-conversion process in which the laser pump frequency is added to an intense, broad-band source of infra-red radiation. Pulse power output, which increases with wavelength, ranges from about 1 W at 0.5 μm to about 20 kW at 0.7 μm .

Microwave Standards.—The N.B.S. Institute for Basic Standards (U.S. Department of Commerce) is serving as a pilot laboratory in an international cross check of microwave power standards at 3 Gc/s. Canada, Japan, U.S.A., and the U.S.S.R. are each supplying one or more transfer standards which will be compared with the primary standards in all four countries. Measurements on the transfer standards have been completed at N.B.S., and they are now being compared with the primary standards in Canada. Data obtained at each national laboratory will be reported to the International Bureau of Weights and Measures at Sèvres, France, which will issue a final report when all the results have been collated.

A sale of American surplus electronic equipment to be held at R.A.F. Molesworth in mid-December will be of interest to dealers and amateur clubs. The equipment will be divided into lots and prospective buyers are required to submit sealed bids before the sale, the highest bid being accepted. Interested parties should contact Mr. Peller, R.A.F. Molesworth, Huntingdonshire, for full details.

An outside broadcast of parachuting, transmitted direct from the aircraft carrying the parachutists started the French colour television service on October 1st. Inaugurated by the French Information Minister Georges Gorse, the programmes continued until late evening to mark the introduction of colour television in Russia at the same time. The parachuting was also seen in Britain over the Eurovision link.

Journal of Physics is the new overall title for the major scientific journals published by the Institute of Physics and the Physical Society. This change in publishing procedure is intended to aid the circulation of British physics information abroad, particularly in North America.

Last month, in the article **Digital Voltmeter Techniques** an error occurred in Fig. 14(a) page 524. The two arrows associated with this diagram should point in opposite directions.

PERSONALITIES

Arthur E. Bailey, M.A., F.I.E.E., has been appointed superintendent of the National Physical Laboratory's new Division of Electrical Science. Born in 1920 he graduated at Sidney Sussex College, Cambridge, in 1940 and joined the Air Defence Experimental Establishment, first at Christchurch



A. E. Bailey

and then at Malvern. From 1946 to 1952 he was in charge of the anti-mutter and display section. He then spent two years with the U.S. Signal Corps Engineering Laboratories, New Jersey, as chief of the applied research unit in the Radar Division. In 1954 he returned to R.R.E. Malvern, to undertake research on ground radar systems. Three years later he took charge of radio research at the Government Communications Headquarters, Cheltenham, and in 1962 was appointed to a new post at the Signals Research and Development Establishment, Christchurch, as head of the strategic systems division, where he was responsible for research and development on long-distance military communications systems.

H. Page, M.Sc., F.I.E.E., head of the radio group in the B.B.C. Research Department, Kingswood Warren, since 1962, has retired and has been appointed reader in communications systems in the Electrical Engineering Department of Imperial College, London. Mr. Page joined the Corporation in 1935, after graduating at Manchester University, and, apart from one year when he was in the Planning and Installation Dept., has spent the whole of his career in the Research Department. The new head of the radio group is **G. D. Montheath, B.Sc., F.I.E.E.**, who joined the B.B.C. Research Dept. in 1947, after graduating at the Royal College of Science. He was appointed head of the television group in 1961 and has been head of the physics group since 1966. **A. V. Lord, B.Sc.(Tech.), F.I.E.E.**, head of the

electronics group for the past year or so, takes charge of the physics group. Mr. Lord graduated at Manchester University in 1941 and joined the Research Dept. in 1948. He was assistant head of the television group from 1961-66. The new head of the electronics group is **E. R. Rout, M.I.E.E.**, who has been with the Research Dept. since 1950. He was appointed head of the video frequency section in the television group in 1961 and since 1966 has been head of the special projects section in the electronics group.

William V. Barbone, recently appointed technical manager of the Marconi Company's Space Communications Division, joined the company in 1947 after five years with Army chain communications in the Royal Signals. Mr. Barbone, who is 43, was initially concerned with transmitter development and later played a leading part in the design of Marconi



W. V. Barbone

high-power u.h.f. tropospheric scatter equipment. Since 1964, he has been engineering manager, Radio Communications Division.

Rex N. Baldock, B.Sc., has resigned from G.E.C., with which he has been associated for 22 years, in order to concentrate on writing and consulting in the audio field. For the first seven years of his service with G.E.C. he was in the Research Laboratories at Wembley, and since 1952 has been in the Applied Electronics Laboratories at Stanmore working on analogue computers and latterly test equipment. He was for several years honorary lecture secretary of the British Sound Recording Association (now amalgamated with the B.K.S.T.S.), and in 1960 won the *Wireless World* prize in the B.S.R.A. constructors' competition with a v.h.f./f.m. receiver with pulse counter discriminator.

Robert A. Smith, C.B.E., Ph.D., F.R.S., newly appointed principal and vice-chancellor of Heriot-Watt University, Edinburgh, was at the Telecommunications Research Establishment (now R.R.E.) from 1939 to 1961. For the major part of the time Dr. Smith was head of the Physics Department.



Dr. R. A. Smith

In 1961 he was appointed professor of physics at Sheffield University. Since 1962 he has been professor of physics and first director of the Center of Materials Science and Engineering at the Massachusetts Institute of Technology. Professor Smith graduated at Edinburgh University with the degree of M.A. in 1930 and obtained his B.A. at Cambridge in 1932. In 1936, after three years' research at the Cavendish Laboratory, he received his Ph.D.

R. B. Quarmby, M.Sc., F.I.E.E., has been appointed chief engineer of the Painton group of companies, which includes Painton, Elcom, and Electroprints. Mr. Quarmby has been for



R. B. Quarmby

ten years with English Electric, where he was assistant chief engineer of the Reactor Equipment Division and prior to this he was with Ferranti.

Alan James, B.Sc., F.I.E.E., engineer-in-charge of the I.T.A.'s transmitting station at Calbeck, Cumberland, since 1965, has been appointed the Authority's senior engineering liaison officer. After graduating



A. James

at the University of Birmingham in 1948 he spent seven years with Marconi, initially as a graduate apprentice and later on the design and development staff. In 1955 Mr. James joined the Colonial Service and was with Nigerian Posts & Telegraphs immediately prior to joining the headquarters' staff of I.T.A. in 1958 as senior engineer in the Operations and Maintenance Department. He is 40.

Each year a committee reviews the work of scientists carrying out research work in Government Establishments and in similar establishments of other public bodies and recommends the promotion of individual research workers of exceptional merit. Among this year's promotions are several working in the fields of electronics, telecommunications and radio physics. **K. C. Bowen, B.A.**, of the Defence Operational Analysis Establishment, **J. Croney, B.Sc., Ph.D.**, Defence Admiralty Surface Weapons Establishment, and **C. Hilsum, B.Sc., Ph.D.**, Royal Radar Establishment, are appointed deputy chief scientific officers which "is broadly comparable with that of a professor at a university." Mr. Bowen, who is 48, took his B.A. with honours in mathematics at Oxford in 1940. He joined the Admiralty Signals Establishment in 1941. For two years from 1954 he was head of the Establishment's operational research assessment group concerned with gunnery radar, periscope detection radar, strategic communications and sea clutter. He then joined the Department of Operational Research, Admiralty, and for five years from 1960 was head of the war studies group. In 1965 he was transferred to his present post at the Defence Operational Analysis Establishment as superintendent operational studies (sea). Dr. Croney, who is 55, gained an external B.Sc., with 1st class honours in electrical engineering (telecommunications) at London University. He joined H.M.

Signal Establishment in 1939 working on the early development of v.h.f. radar receivers. In 1951 he became head of a division at T.R.E. carrying out research into navigational aids for civil marine and the Navy. In 1953 he was appointed to lead a new Techniques Division concerned primarily with aeriels and inertialess scanning. His researches on sea clutter and clutter reduction techniques led to the award of the Ph.D. of London University in 1966. Dr. Hilsum, who is a member of the Physics Group of the R.R.E., graduated in physics at University College, London, in 1945 and joined the Royal Navy Scientific Service the same year. He was at one time in the Services Electronics Research Laboratory at Baldock, where he worked on the applications of indium antimonide and in 1960 he was one of the earliest workers on the electronic properties of gallium arsenide. In 1962 he published a paper on transferred electron amplifiers and oscillators which outlined the theory of the negative resistance effect in electronic materials having a conduction band consisting of two different energy minima, the electron mobility in the higher minimum being lower than in the other. He predicted that high fields in gallium arsenide and gallium antimonide should result in negative resistance oscillations, since they have the required band structure. The effect was noted by J. B. Gunn in the laboratory shortly after this paper and Dr. Hilsum seriously took up the practical aspects shortly after joining R.R.E. in 1964. The results of his research programme, which has been tightly co-ordinated with industry, have resulted in the development of Gunn diodes. Dr. Hilsum was awarded a Ph.D. by London University in 1959 for a thesis on the conversion of thermal radiation patterns into visible pictures.

Among research workers promoted to the grade of senior principal scientific officer (equivalent to a reader at a university) are **Dr. G. H. Byford** who is in charge of the instrumentation and electronics section of the R.A.F. Institute of Aviation Medicine, where he has developed an extensive and sophisticated central data recording and progressing facility; **Dr. H. A. French**, Admiralty Surface Weapons Establishment, who is engaged in the design and evaluation of advanced signal processing systems, using correlation techniques and computer-aided pattern recognition processes; **Dr. J. M. Linke**, Post Office Research Station, who has been very prominent in advancing both the theory and practice of "time-domain networks"; **Dr. E. G. S. Paige**, a member of the Physics Group at the R.R.E., engaged on researches into the use of the acousto-electric effect for the generation of u.h.f. oscillations and into the general field of plasma effects in solids; **P. H. Parkin**, Building Research Station, whose work in the field of acoustics particularly his system of "assisted resonance" which was installed in the Royal Festival Hall to increase the

reverberation time of particular frequencies is well known; **Dr. E. R. Pike**, R.R.E., who is engaged on work in the theoretical field supporting the research programme on special electronic materials; and **D. E. Weston**, Admiralty Research Laboratory, who is working in the field of oceanographic acoustics and is particularly concerned with studies of sound propagation in the oceans and in marine bio-acoustics.

L. C. Jesty, D.Sc., F.I.E.E., who went to the U.S.A. in 1962 to join the Westinghouse Corporation, has returned to the U.K. to become Research Fellow in Electronics with special reference to educational technology at Chelsea College of Science and Technology, University of London. Dr. Jesty, who received his doctorate from London University in 1966 for his work in the field of "the science of visual communication and display," is a graduate of University College, Southampton. He spent 18 years in the G.E.C. Research Laboratories, Wembley, until 1945, when he joined Cintel Ltd. as head of the advanced development department.



Dr. L. C. Jesty

From 1949 until 1955 he was chief of the television research group in the Marconi Research Laboratories, Gt. Baddow, Essex, and for seven years immediately prior to going to America Dr. Jesty was manager of the Sylvania-Thorn colour television laboratories at Enfield, Middx.

OBITUARY

Cecil E. Watts, well known for his work in the field of disc recording and reproducing, died on September 15th aged 70. He reproduced over the years many thousands of photomicrographs of styli points and record grooves and was the inventor of the "Dust Bug."

E. B. Dotesio, who died on October 6th aged 72, was a founder member in 1911/12 of the radio society of what is now the Fitzmaurice Grammar School, Bradford on Avon, and served as a telegraphist in World War I.

WORLD OF AMATEUR RADIO

Australis OSCAR

AN Orbiting Satellite Carrying Amateur Radio designed and constructed by radio amateurs associated with Melbourne University is likely to become OSCAR 5, although up to the beginning of November no date had been fixed for its launching from a missile site in the United States. Unlike the two previous OSCARs to go into orbit, the Australian satellite is not of the translator type but will emit identical signals in the 2-m and 10-m amateur bands with eight telemetric channels, including the usual HI HI identification in Morse which will be transmitted by a.f.s.k. with two tones and not m.c.w. Powered by two 20-V alkaline-manganese batteries, the satellite is expected to have a life of about two months. To conserve battery power the 10-metre transmitter will be of the command type capable of being switched on and off from ground stations.

The 2-metre transmitter will continuously emit an a.m. signal and telemetric information in the following sequence on 144.050 Mc/s using a power of 50 mW:

Channel	Information
0	HI HI
1	Battery-current drain (in milliamps)
2	X axis sensor
3	Battery voltage
4	Y axis sensor
5	Internal Temperature
6	Z axis sensor
7	Skin temperature of package

In all cases the parameter will be specified by the audio frequency of the signal and not by a time count, as previously. Each channel will operate for approximately 6.5 seconds giving a total time of 52 seconds for the complete cycle. Frequencies will vary from about 500 to 1,500 c/s and graphs to convert the frequency received to actual battery and temperature values can be obtained from W. Browning, G2AOX, 47 Brampton Grove, London, N.W.4, who has been invited to act as director of the Australis OSCAR Project in the I.T.U. Region I.

For the first time in an amateur radio satellite an attempt has been made to stabilize the package to ensure reliable reception, free from fading due to spin, roll and tumble.

The same telemetry sequence as outlined above will be transmitted on 2945 Mc/s. Power will be 250 mW and the signal should serve as a useful indication of propagation conditions on the 10-m amateur band.

Special report forms will be sent to all who write to Mr. Browning and details of the launch will be announced via the R.S.G.B. News Bulletin Service which operates from 09.30 to 12.00 on Sundays on 3.6 Mc/s.

Amateur Radio on "Queen Mary."—An amateur station using the call sign GB5QM is being operated from the *Queen Mary* on her last voyage from Southampton, via Cape Horn, to Long Beach, California, where she is due to dock on December 9th. Operation is in the 7, 14, 21 and 28 Mc/s amateur bands and the operators are United States amateurs. QSL cards should be sent to the Associated Radio Amateurs of Long Beach, Box 7493, Long Beach, California.

Reciprocity.—A reciprocal agreement has been signed between Switzerland and the United Kingdom which permits the radio amateurs of one country to operate within the territory of the other, subject to the conditions of the agreement. A similar agreement has been signed between the Swiss and United States administrations.

French S.H.F. Firsts.—Two French amateurs, F2FO (at Montrouge) and F5BO/P recently established contact on 2,300 Mc/s over a line-of-sight distance of 45 km and later repeated the feat on 10,000 Mc/s, both contacts being "firsts" for French radio amateurs. The power used by F2FO on 10,000 Mc/s was only 350 mW.

Rhodesian Amateurs on 70 Mc/s.—The Rhodesian Telecommunications Controller has announced that radio amateurs in that country may now use frequencies in the band 69.75 to 70.15 Mc/s. Input power is limited to 25 watts for fixed stations and 10 watts for mobiles and the facility is conditional on no interference being caused to other Services using the band. Rhodesia thus joins the small number of countries in I.T.U. Region I whose amateurs are authorized to use frequencies around 70 Mc/s. United Kingdom amateurs were the first to enjoy that facility and are, in fact, authorized to operate between 70.1 and 70.7 Mc/s with a maximum input power of 50 watts. During recent weeks a number of two-way contacts have taken place in the band between amateur stations in the U.K. and Gibraltar. The opening-up of the band to Rhodesian amateurs will provide further opportunities for trans-equatorial scatter experiments.

Polish Amateur on 6 metres.—One of Poland's leading v.h.f. amateurs, Eng. Wieslaw Wysocki, SP2DX, has received permission from his country's Ministry of Telecommunications to operate in the band 50-54 Mc/s, a band not normally available to amateurs in Poland. It is not known how many amateurs in I.T.U. Region I have permission to use the 50 Mc/s band but it is not available to amateurs in the United Kingdom. Shortly after World War II a few amateurs in this country were granted permission to carry out special tests around 50 Mc/s but that facility, as well as permission to use the 56-60 Mc/s band was lost to them as a consequence of decisions reached at the 1947 Atlantic City Conference. The 56 Mc/s band was one of the most popular bands in use prior to and immediately after World War II.

Railroad Radio Amateurs meet in Denmark.—Radio amateurs interested professionally in the work of railways held their 1967 Conference in Ribe, South Jutland, during the last week-end in August. Organized by the Danske Jernbaners Amateur Radio Club, the conference was attended by more than 100 amateurs from 12 countries, including the United Kingdom. Held under the auspices of the Federation Internationale des Radio Amateurs Cheminots (F.I.R.A.C.), it was the fifth of the series of conferences started seven years ago in Geneva. The 1968 conference will be held in Austria. The secretary is G. Bessort (LX1BW), 9 Rue Schloss, Clervaux, Luxembourg.

V.H.F. Field Day Results.—Overall winners in the V.H.F. National Field Day event organized by the R.S.G.B. and held during the weekend September 3rd-4th, were a team of amateurs from the mainland who operated a portable station on the Channel Island of Alderney. Runners-up were the Reigate Amateur Transmitting Society.

Pakistan Licences.—The Radio Society of Great Britain has been notified by Mr. Ahmed Ebrahim, AP2AD, that his licence has been restored. If this means that amateur radio activity generally has been resumed in Pakistan it reflects great credit upon AP2AD and others who have been negotiating with the authorities to bring about a lifting of the restrictions that have kept Pakistan amateurs off the air for a very long time.

Thailand Activity.—Mr. Arthur Goddard, HS1CW/K1AII, in a report to the International Amateur Radio Club, records that although Thailand has objected, under Article 41 of the I.T.U. Radio Regulations, to communication between radio amateurs in that country and those of other countries, about 45 amateur stations are, in fact, operating under HS call-signs. The Radio Society of Thailand has taken the responsibility for the issue of call signs and the operation of the country's QSL Bureau.

JOHN CLARRICATS, G6CL

DIODE FUNCTION GENERATORS

A unified design approach for signal-modifying networks with straight-line approximation of characteristics

By A. E. CRUMP*

A FUNCTION generator, as far as this article is concerned, is a network which modifies the amplitude of a signal fed to its input according to a predetermined law. By this definition, the simple diode clamp can be regarded as a function generator and the design philosophy involved may be applied to this as well as the more complex function generators. It can be shown that the most complex waveform or characteristic can be approximated by a number of straight lines of varying length and slope. The greater the number of lines, the greater the correlation to the ideal.

The simple diode clamp (see Fig. 1) has a characteristic that consists of a single straight line which is usually required to be as near horizontal as possible. The clamp, however, is usually required to become operative only when the signal applied to it exceeds a predetermined level V_b . This level will be referred to as the "break" point, i.e., the point at which the output signal differs from the input signal. The slope of the line may be predetermined by suitable choice of circuit components and configuration, and a series of these simple clamps connected in parallel, each with its own line slope and break point, can perform more complicated clamping patterns (Fig. 2).

The passive forms of function generator described above are limited to applications where the output signal never exceeds the input signal. Should a function be required where the output signal exceeds the input then some voltage gain must be introduced into the system in such a way that the gain is either directly or inversely proportional to the diode clamp slope lines (Fig. 3).

The fact that diodes do not conduct abruptly when the knee voltage is reached is an advantage in the design of function generators which are to simulate curved functions. The effect of the diode is to round off the otherwise abrupt transition from one slope to another at each break point (Fig. 4).

Functions to be generated do not always start from zero but may be as Fig. 5(a). Alternatively, the function may pass through zero and may or may not be symmetrical about zero (Figs. 5(b) and (c) respectively). The design philosophy will be based on the unipolar cases only as it is a simple matter to modify break point polar-

ities should the bipolar type be required, by having both positive and negative reference voltages. For cases where the function does not pass through zero, an operational amplifier method must be used, with an offset factor introduced at its input.

It is not possible to generate any function with zero error because of (1) Manufacturing spread on components. (2) Temperature changes and other environmental considerations. (3) Effects such as printed circuit track resistance, etc.

A practical approach is to consider the errors contributed by each individual clamp at each break point and then add them algebraically. This method does not allow for the fact that diode voltage drop will increase at higher signal levels due to the increased forward current, therefore, when all circuit values are known, a correction must be made. If this is to be done accurately each individual diode current must be calculated at each break point and this can be tedious. As the change in diode voltage drop is a second order effect in most applications, a faster, though less accurate solution would be to design the generator to be 20% better than required.

DESIGN ANALYSIS FOR THE SIMPLE CLAMP

Consider the two-slope function shown in Fig. 6(c). K_0 is the slope of the unclamped region. K_1 is the slope of the region above the break point. The circuit of Fig. 6(a) is suitable for generating this simple function, and can be represented by the circuit matrix:—

$$\begin{bmatrix} V_{IN} - V_{REF} - V_1 \\ V_{IN} - V_{REF} - V_1 \end{bmatrix} = \begin{bmatrix} (S+L) & S \\ S & (S+R_1) \end{bmatrix} \begin{bmatrix} I_1 \\ I_2 \end{bmatrix} \quad \dots \quad (1)$$

Solving for $V_{OUT} = I_1 L$ yields:—

$$V_{OUT} = \frac{V_{IN} + (V_{REF} + V_1)(S/R_1)}{1 + S\left(\frac{1}{L} + \frac{1}{R_1}\right)} \quad \dots \quad (2)$$

Expression (2) is valid for the K_1 region where the diode is conducting. The expression for V_{OUT} in the K_0 region can be obtained by reverse biasing the diode mathematically, i.e. putting $I_2 = 0$.

$$\text{Then } V_{OUT} = \frac{V_{IN}}{1 + S/L} \text{ in the } K_0 \text{ region } \quad \dots \quad (3)$$

The equation (3) is the standard potential divider formed by S and L .

To determine the values of K_0 and K_1 , refer to the small signal equivalent circuit Fig. 6(b), from which it is apparent that in the K_1 region:—

$$K_1 = \frac{d(V_{OUT})}{d(V_{IN})} = \frac{1}{1 + S\left(\frac{1}{L} + \frac{1}{(R_1 + r_1)}\right)} \quad \dots \quad (4)$$

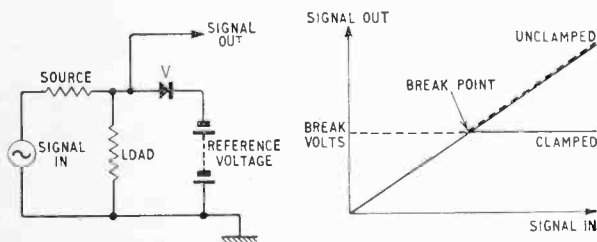

Fig. 1. The basic clamp circuit.

*Plessey Automation Ltd.

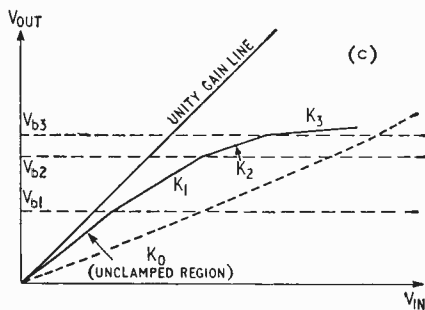
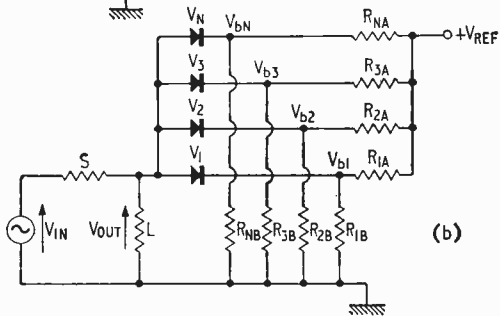
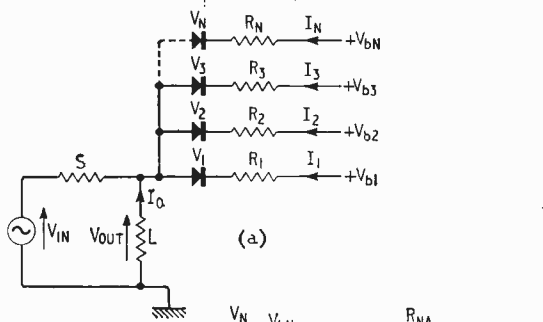

Fig. 2(a). Multi-slope clamp circuit showing the d.c. current paths. (b) Practical realization of (a) using a common reference voltage. (c) The type of function generated by (b). Dotted curve with diodes reversed.

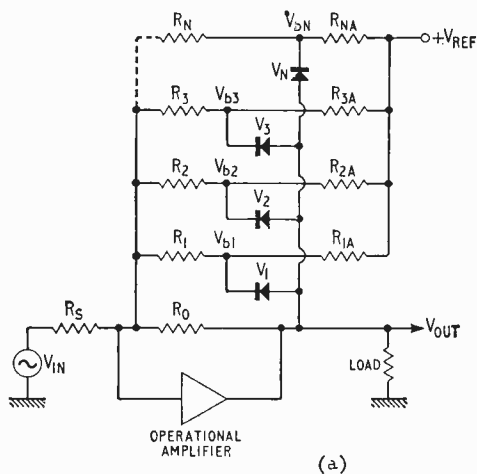

Fig. 3(a). An active function generator.

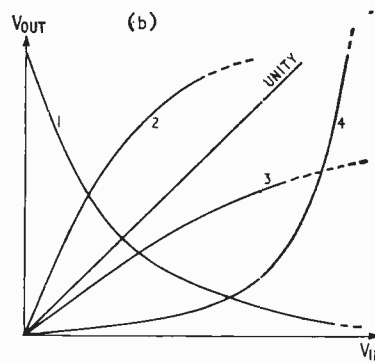

Fig. 3(b). 1.—Using inverting operational amplifier with offset. 2—Amplifier gain > 1. 3—Amplifier gain < 1. 4—as 2 with diodes reversed.

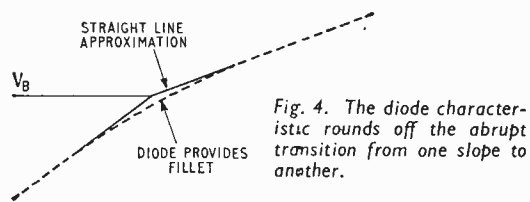

Fig. 4. The diode characteristic rounds off the abrupt transition from one slope to another.

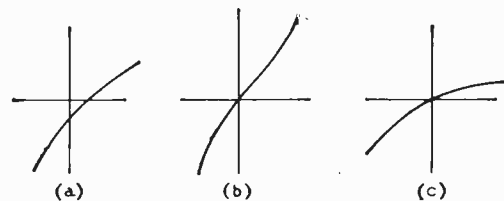

Fig. 5. Types of functions that may be generated, these do not always start from zero.

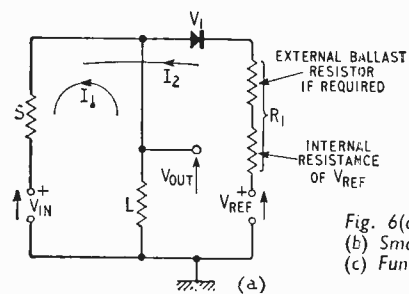
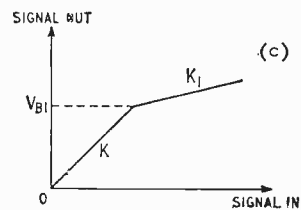
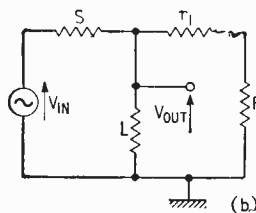

Fig. 6(a). A clamp circuit (b) Small signal equivalent. (c) Function generated.



Note that (4) could have been obtained by substituting $(R_1 + r_1)$ for R_1 in (2) and differentiating with respect to V_{IN} . In like manner, differentiate (3) to obtain K_0 :-

$$K_0 = \frac{d(V_{OUT})}{d(V_{IN})} = \frac{1}{(1 + S/L)} \dots \dots \dots (5)$$

ERRORS DUE TO TEMPERATURE CHANGES

Diodes. The value of V_1 will be temperature dependent, typically 2 mV/C° for a silicon diode. The effect of this change upon the value of V_{OUT} is obtained from the expression:-

$$\frac{d(V_{OUT})}{dT} = \frac{d(V_1)}{dT} \left(\frac{1}{1 + R_1 \left(\frac{1}{S + L} \right)} \right) \dots \dots \dots (6)$$

The effect of V_1 drift can be corrected by using a compensating diode or diodes as shown in Fig. 7. For perfect compensation this diode would need to have similar characteristics to the clamp diode and be operating under the same conditions. Diode arrays are currently available, contained within a single monolithic chip, thus helping considerably with temperature tracking.

Resistors. Resistors will alter in value with changes in ambient temperature producing an error in the generated function. Referring to expression (2) it is apparent that if the ratios S/R_1 and S/L remain constant, then the value of V_{OUT} is unchanged. If resistors of closely matched temperature coefficient are used the effect on V_{OUT} is minimal. Thin film techniques are eminently suitable for this application. It should be noted that R_1 is the total effective resistance of the reference supply including external ballast resistance and in most cases this ballast resistance will be the dominant term so that coefficient matching may be used as above. Where the ballast is either zero or small compared to the internal resistance of the reference supply one cannot presume that close tracking will take place and therefore the temperature coefficient of the output resistance of the supply must be considered.

As previously discussed, it is the ratio between resistance values that is important and thin film techniques are ideal in this respect. In cases where thin film processes are not used a thermistor may be connected in series with the resistor(s) in question. The temperature coefficient of thermistors is much greater than that of resistors so they need to be heavily shunted by a resistance to obtain the correct composite value of temperature coefficient.

Fig. 7. Showing the position of the compensating diode.

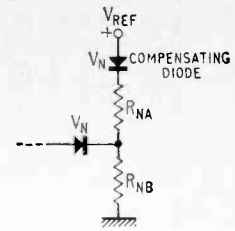

MULTI-SLOPE PASSIVE FUNCTIONS

The preceding discussions have been concerned with a K_0, K_1 function, i.e., a single slope above the K_0 region. The same theory can be applied to multi-slope functions by considering each slope separately and constructing an overall tolerancing diagram for the complete function. Take a value of V_{IN} at the centre of each slope and calculate the limits of V_{OUT} at these points. When calculating the excursion of V_{OUT} at each centre point it is essential to consider both the static and the dynamic conditions. The static condition yields the spread due to changes in d.c. conditions (for example changes in diode forward drop), and the dynamic case gives information regarding the change in the slope.

To graph the overall anticipated spread of a function calculate the function spread d.c.-wise, assuming constant slopes, then calculate the slope spreads and superimpose these on the d.c. plot, see Fig. 8. (Note that the errors in Fig. 8 have been exaggerated in the interests of clarity.) In Fig. 8(a) the line *BOE* represents the calculated d.c., or static spread, about the ideal characteristic centred on 0. Lines *ABC* and *DEF* are then drawn parallel to the ideal slope concluding the first stage in the construction. Fig. 8(b) shows the max. and min. slope values drawn through *B* and through *E*. The lines *GBH* and *JEK* define the theoretical worst-case boundary conditions between which the function will lie. Fig. 8(c) shows the effect of performing this construction on a multi-slope function. With this type of function the errors accrue as the number of slopes increases, i.e., slope K_3 will be a function of slope networks K_0-K_3 inclusive whereas K_1 will depend only on the components defining K_0 and K_1 . The formulae from which static and dynamic condition spreads can be calculated may be derived in a completely generalized form which can be expanded to cover any number of slopes without extra analysis.

Consider the general determinant for an N-slope function derived by normal mesh methods using the basic circuit of Fig. 2.

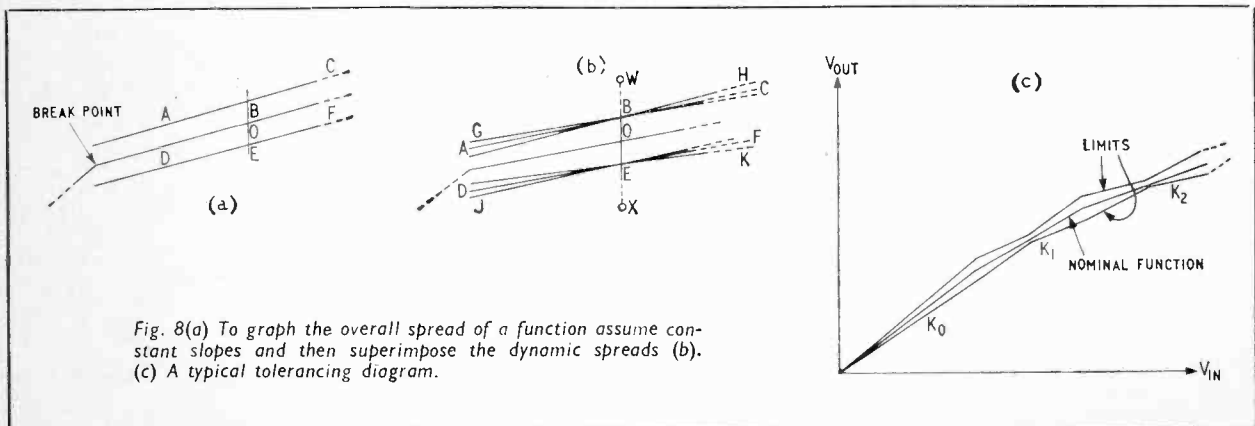

Fig. 8(a) To graph the overall spread of a function assume constant slopes and then superimpose the dynamic spreads (b). (c) A typical tolerancing diagram.

$$\begin{bmatrix} (V_{IN} - V_1 - V_{b1}) \\ (V_{IN} - V_2 - V_{b2}) \\ (V_{IN} - V_3 - V_{b3}) \\ (V_{IN} - V_4 - V_{b4}) \\ \vdots \\ (V_{IN} - V_N - V_{bN}) \end{bmatrix} = \begin{bmatrix} (S+L) & S & S & S & S & \dots & S \\ S & (S+R_1) & S & S & S & \dots & S \\ S & S & (S+R_2) & S & S & \dots & S \\ S & S & S & (S+R_3) & S & \dots & S \\ S & S & S & S & (S+R_4) & \dots & S \\ \vdots & \vdots & \vdots & \vdots & \vdots & \ddots & \vdots \\ S & S & S & S & S & \dots & (S+R_N) \end{bmatrix} \begin{bmatrix} I_0 \\ I_1 \\ I_2 \\ I_3 \\ I_4 \\ \vdots \\ I_N \end{bmatrix} \quad (7)$$

Now if rows and columns 3 onwards are deleted, we are left with a second-order determinant of similar form to (1) which is a two-slope function. Similarly, if rows and columns 4 onwards are deleted, we are left with a 3rd-order determinant which applies to a 3-slope function. Hence the order of the determinant is equal to the number of slopes in the function.

Static conditions. Solution of the determinant produces the general expression:—

$$V_{OUT} = \frac{V_{IN}(\Delta_{11}) - (V_{IN} - V_1 - V_{b1})\Delta_{12} + (V_{IN} - V_2 - V_{b2})\Delta_{13} - (V_{IN} - V_3 - V_{b3})\Delta_{14} + \dots \text{etc.}}{\Delta(1/L)} \quad (8)$$

which reduces to:—

$$V_{OUT} = \frac{V_{IN}(\Delta_{11} - \Delta_{12} + \Delta_{13} - \Delta_{14} + \dots \text{etc.}) + \Delta_{12}(V_1 + V_{b1}) - \Delta_{13}(V_2 + V_{b2}) + \Delta_{14}(V_3 - V_{b3}) - \dots \text{etc.}}{\Delta(1/L)} \quad (9)$$

Notice how the signs alternate in the numerator of (9) The effect of changes in diode forward voltage drop with temperature upon the value of V_{OUT} is obtained by partial differentiation of (9) which yields:—

$$\frac{d(V_{OUT})}{dT} = \frac{L}{\Delta} \left[\Delta_{12} \left(\frac{dV_1}{dT} \right) - \Delta_{13} \left(\frac{dV_2}{dT} \right) + \Delta_{14} \left(\frac{dV_3}{dT} \right) - \dots \text{etc.} \right] \quad (10)$$

If good tracking between diodes can be obtained then it is possible to simplify (10) to:—

$$\frac{d(V_{OUT})}{dT} = L \left(\frac{dV_1}{dT} \right) \left[\Delta_{12} - \Delta_{13} + \Delta_{14} - \Delta_{15} \dots \text{etc.} \right] \quad (11)$$

Compensation of Static Case: By the method previously described, a diode may be included in series with each reference source voltage for compensation purposes. The temperature dependent factor then becomes the differential temperature co-efficient of the diode pairs, and (10) becomes:—

$$\frac{d(V_{OUT})}{dT} = \frac{L}{\Delta} \left[\Delta_{12} \left(\frac{\delta V_1}{dT} \right) - \Delta_{13} \left(\frac{\delta V_2}{dT} \right) + \Delta_{14} \left(\frac{\delta V_3}{dT} \right) - \dots \text{etc.} \right] \quad (12)$$

where δV_1 etc. is the difference between temperature coefficients of the clamp and the compensating diode.

Dynamic Conditions: The dynamic conditions are derived by substituting for V_1, V_2, V_3 , etc. in terms of their small signal slope resistances.

$$V_1 = i_1(r_1) \therefore R_1 \text{ becomes } (R_1 + r_1) \quad V_2 = i_2(r_2) \therefore R_2 \text{ becomes } (R_2 + r_2) \quad V_3 = i_3(r_3) \therefore R_3 \text{ becomes } (R_3 + r_3)$$

$$\text{Hence from (9)} \quad \frac{d(V_{OUT})}{d(V_{IN})} = \frac{L(\Delta_{11} - \Delta_{12} + \Delta_{13} - \Delta_{14} + \dots \text{etc.})}{\Delta} \quad (13)$$

making the above substitutions for R_1, R_2, R_3 , etc. within the determinants.

Realisation of equations (8)-(12). Solving the various sub-determinants, and the overall determinant yields some very important points.

(1) **Static Conditions:** Equation (9) becomes:—

$$V_{OUT} = \frac{[V_{IN}/S + (V_1 + V_{b1})/R_1 + (V_2 + V_{b2})/R_2 + (V_3 + V_{b3})/R_3 + \dots + (V_N + V_{bN})/R_N]}{(1/S + 1/L + 1/R_1 + 1/R_2 + 1/R_3 + \dots + 1/R_N)} \quad (14)$$

Equation (10) becomes:—

$$\frac{d(V_{OUT})}{dT} = \frac{\left[\frac{1}{R_1} \left(\frac{dV_1}{dT} \right) + \frac{1}{R_2} \left(\frac{dV_2}{dT} \right) + \frac{1}{R_3} \left(\frac{dV_3}{dT} \right) + \dots + \frac{1}{R_N} \left(\frac{dV_N}{dT} \right) \right]}{\left(\frac{1}{S} + \frac{1}{L} + \frac{1}{R_1} + \frac{1}{R_2} + \frac{1}{R_3} + \dots + \frac{1}{R_N} \right)} \quad (15)$$

(2) **Dynamic Conditions:** Equation (13) becomes:—

$$\frac{d(V_{OUT})}{d(V_{IN})} = \frac{1}{1 + S \left[\frac{1}{L} + \frac{1}{(R_1 + r_1)} + \frac{1}{(R_2 + r_2)} + \dots + \frac{1}{(R_N + r_N)} \right]} \quad (16)$$

It is clear that these equations are completely general and of very simple form hence easy to apply in practice.

For the compensated case (12) can be written as:—

$$\frac{d(V_{OUT})}{dT} = \frac{\left[\frac{1}{R_1} \left(\frac{\delta V_1}{dT} \right) + \frac{1}{R_2} \left(\frac{\delta V_2}{dT} \right) + \frac{1}{R_3} \left(\frac{\delta V_3}{dT} \right) + \dots + \frac{1}{R_N} \left(\frac{\delta V_N}{dT} \right) \right]}{\left(\frac{1}{S} + \frac{1}{L} + \frac{1}{R_1} + \frac{1}{R_2} + \frac{1}{R_3} + \dots + \frac{1}{R_N} \right)} \quad (17)$$

MULTISLOPE ACTIVE FUNCTION

The problem here is tackled in a similar manner to that described for the passive case, i.e., superimposition of the dynamic spread upon the static spread.

Static Conditions: In addition to the diode network spread it is necessary to consider the d.c. spread of the operational amplifier. The amplifier d.c. spreads are due to the temperature co-efficient of input offset voltage and differential input currents. These produce small voltage shifts at the input which are multiplied up by the gain of the amplifier. If the amplifier is used in a high gain mode, the effect of these drifts will be more marked. Thus static drift = Drift due to Amplifier ± Drift due to diode network.

Drift due to diode network: To calculate the static conditions one can refer to Fig. 9 and from experience gained with the passive case it is relatively simple to derive the expression:—

$$V_{OUT} = \frac{[V_{IN}/S + V_1/R_1 + V_2/R_2 + V_3/R_3 + \dots + V_N/R_N]}{\left(\frac{1}{R_0} + \frac{1}{R_1} + \frac{1}{R_2} + \frac{1}{R_3} + \dots + \frac{1}{R_N}\right)} \dots \dots \dots (18)$$

$$\therefore \frac{d(V_{OUT})}{dT} = \frac{\left[\left(\frac{dV_1}{dT}\right) \frac{1}{R_1} + \left(\frac{dV_2}{dT}\right) \frac{1}{R_2} + \left(\frac{dV_3}{dT}\right) \frac{1}{R_3} + \dots + \left(\frac{dV_N}{dT}\right) \frac{1}{R_N}\right]}{\left(\frac{1}{R_0} + \frac{1}{R_1} + \frac{1}{R_2} + \frac{1}{R_3} + \dots + \frac{1}{R_N}\right)} \dots \dots \dots (19)$$

Dynamic Conditions. The dynamic conditions are obtained by differentiating (18) and putting $R_1' = (R_1 + r_1)$, $R_2' = (R_2 + r_2) \dots R_N' = (R_N + r_N)$

∴ for dynamic conditions:—

$$d(V_{OUT}) = \frac{1}{S \left[\frac{1}{R_0} + \frac{1}{R_1'} + \frac{1}{R_2'} + \frac{1}{R_3'} + \dots + \frac{1}{R_N'} \right]} \dots (20)$$

Drift due to Amplifier: Let the total drift due to both offset current and voltage be $E \mu V/^\circ C$, referred to the input. Now at the centre-point of each slope the overall gain will be different. Thus the multiplication of E which appears at the amplifier output varies as the gain varies. Thus to K_0 centre point, the output of the operational amplifier will drift $K_0 E \mu V/^\circ C$ and so on so that in the K_N slope we have $K_N E \mu V/^\circ C$. Thus Drift at output = $K_N E \mu V/^\circ C \dots \dots \dots (21)$.

GRAPHICAL CONSTRUCTION OF TOLERANCING DIAGRAM

- (1) Construct line *BOE* (Ref. Figs. 8 and 9) at the centre point of each slope using equations (18), (19).
- (2) From (21) calculate the effect of amplifier drift, add this algebraically to the line *BOE* to produce the new line *WBOEX*. Do this at each centre point.
- (3) Draw lines parallel to *ABC* through points *W* and *X*.
- (4) Superimpose the dynamic spreads upon the lines drawn in (3)—this gives the overall boundary conditions.

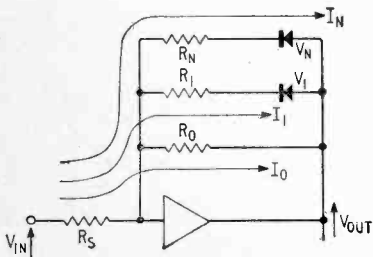

Fig. 9. Equivalent circuit of Fig. 3(a), providing that the open loop gain of the amplifier is > 100 times higher than the highest K value, the amplifier approximates the ideal.

DESIGN SEQUENCE

- (1) Draw a number of straight lines on the function required and determine the number required to obtain the correct approximation.
- (2) Draw the boundary conditions which would be acceptable.
- (3) Measure the slopes and break points.
- (4) Select suitable component values to obtain these slopes and break points.

Note that once having selected the K_0 components, the values of $R_1 \dots R_N$ can be obtained by successive use of expressions (16) and (20), increasing the order by one each time to obtain the value of the next R component. In the passive case the value of R is often given by the parallel combination of the two bias resistors which fix the break point in each case. Let their values be R_{NA} and R_{NB} and the break point = V break (Ref. Fig. 7).

$$\text{Then } V_{BREAK} = \frac{R_{NB}}{(R_{NA} + R_{NB})} (V_{REF}) \dots \dots (22)$$

but $R_N = R_{NA} // R_{NB} \dots \dots \dots (23)$
 Thus (22) and (23) can be solved simultaneously to find the values of R_{NA} and R_{NB} for each slope. In the active case, the situation is slightly different in that (Ref. Fig. 3) RI_A does not affect the slope, neither does $RI_B \dots$ etc. Thus the slope resistors $R_1 \dots R_N$ can be found by successive use of (20), then $RI_A \dots R_{NB}$ can be found from the appropriate break point, i.e.

$$V_{BREAK} = \frac{R_N}{(R_N + R_{NA})} (V_{REF})$$

$$\therefore R_{NA} = R_N \left(\frac{V_{REF}}{V_{BREAK}} - 1 \right) \dots \dots (24)$$

- (5) Decide upon temperature co-efficients of components, and use the expressions and graphical constructions described in the article to see whether the overall boundary conditions are within the limits required. If not, use more stable components.

Acoustic Domains Scan Image Panels

A SOLID-STATE acousto-electric light generating device developed at Bell Telephone Laboratories, U.S.A., reinforces the possibility of simpler electronic scanning techniques in image sensing and display panels. At present scanning usually has to be done by an x-y matrix system requiring electrical connections to all active elements in an array. The new Bell device*, however, uses a travelling acoustic domain to produce light emission sequentially from a row of p-n junctions. The acoustic domain, which can be considered as a concentration of crystal lattice vibrations, travels at the speed of sound through an n-type cadmium sulphide strip, as shown in the diagram. On top of the cadmium sulphide substrate are p-type cuprous sulphide rectangles, forming the p-n junctions. As the domain sweeps by a p-n junction, the domain voltage (about 200 V) causes local breakdown in the junction. The resulting current flow causes the p-n junction to emit a flash of red light. (Although not shown, light also is actually emitted from the bottom of the device.) The solid-state device is sandwiched between thin glass plates (only the bottom plate being

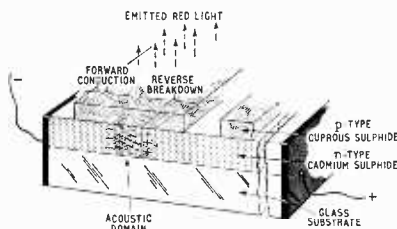

shown) for structural strength. Arrays constructed so far range in size from about 0.4 mm wide by 5 mm long, to one with about 20,000 p-n junctions which measures $\frac{1}{2}$ inch square.

Earlier this year we reported on similar work being done in the U.K. at Standard Telecommunication Laboratories†, but here the scanning was done by electric field domains travelling through gallium arsenide semiconductor and so "reading" a conductivity pattern produced by incident light. This was in fact an extension of the DOFIC (Domain Originated Functional Integrated Circuits) technology devised at S.T.L.

* "Solid-state acoustoelectric light scanner" by B. W. Hakki. *Applied Physics Letters*, Vol. 2, No. 5 (Sept. 1st 1967), pp. 153-155.
 † "Travelling-Domain 'Television Camera?'" *Wireless World*, June 1967.

Bolometric Measuring Device

THE accurate measurement of alternating quantities has always been something of a thorny problem. The method employed in many standards laboratories is to measure the heating effect of a known d.c. current on a thermocouple, thus standardizing the measuring equipment, and then replace the d.c. with the a.c. to be measured. This method can be extremely accurate but it is time consuming and frequent standardization is necessary if accuracy is to be maintained.

A new approach to this problem has been developed at the National Bureau of Standards, Washington, in the form of an instrument known as the Bolovac which will allow precision power, voltage and current measurements up to 20 Gc/s. The Bolovac (Bolometric Voltage and Current standard) is a bolometric "head" that is connected in a coaxial

transmission line between the r.f. source and the load. The power sensitive unit of the Bolovac consists of a conductive film, in the shape of two half discs, deposited on an insulating disc, through which the centre coaxial conductor runs. The greater the r.f. power flowing through the device the more power is absorbed by the two film areas, the hotter they become, and the more their resistance increases.

In use, an easily measured d.c. or audio frequency current is passed through the discs and the resistance of the discs is measured on an external bridge and noted. The r.f. power is applied in addition to the a.f. or d.c. Then the amount the d.c. or a.f. current has to be reduced to obtain the original resistance value is equated with the r.f. power absorbed; from this the total r.f. voltage or current can be computed. An advantage of

this unit is that the Bolovac disc d.c. and r.f. impedances are essentially the same, enabling its sections to be matched by the use of direct current only, eliminating expensive r.f. matching procedures encountered with the more normal bolometric device employing thermistors, etc.

Precision True—r.m.s. Indicator

THE U.K. General Post Office are currently engaged in developing a true r.m.s. measuring instrument that represents a departure from standard techniques. One of the first versions of this device, and the simplest, compares the light output of a lamp fed from a d.c. source with that obtained from the same lamp when fed with the a.c. to be measured; the amount of light is measured using a photo-transistor and an amplifier driven meter. Drift in the photo-transistor and amplifier and the need for an expensive coaxial change-over switch between the a.c. to be measured and the d.c. reference led to the rejection of this idea. However, it was found with the type of lamps used that a small change in voltage produced a large change in light output, indicating that high sensitivity was possible, and the lamp, compared with other devices, had a low thermal inertia, which could lead to a meter with a reasonably fast response time. To eliminate the coaxial changeover switch a system was tried whereby two lamps were used, one for the reference and one for the voltage to be measured. These were focused on to photo-transistors whose outputs were fed to a differential amplifier. A meter in the amplifier was arranged to read zero when the light output, and hence the electrical inputs, were the same from both lamps; once again drift killed this idea.

To eliminate this problem the outputs from the two lamps were focused on the same photo-transistor through a motor-driven shutter, the light from each lamp being allowed to fall on the photo-transistor alternately for the same amount of time. The output of the photo-transistor was fed to a meter, via an amplifier. The meter connections were reversed in synchronism with the shutter by

mercury-wetted relays in such a way as to make the meter deflect one way for the reference and the opposite way for the voltage to be measured. The reference is adjusted until the meter reads zero, then the reference and the voltage being measured will be equal. Any drift in the phototransistor or the amplifier will have equal and opposite effects on the outputs from the two lamps, giving automatic cancellation.

To eliminate the mechanical shutter, Faraday effect in yttrium

iron garnet crystals (y.i.g.) was exploited. If polarized light is passed through a y.i.g. crystal it can be switched by applying a magnetic field to the crystal, the magnetic field rotating the plane of polarization. In the practical unit the outputs from the lamps are passed through polarizing filters and through y.i.g. crystals wound with coils. By rotating the plane of polarization of the crystals either light beam can be selected electronically, this being done in synchronism with the meter reversing

switching, of course. The whole light beam switching unit including the lamps occupies far less than one cubic inch of space and will in practice be built into the r.f. head.

This system has the advantage that there is complete isolation between the reference and the voltage to be measured, is portable, does not require frequent standardization and is virtually instantaneous in operation. The unit is expected to give an accuracy of 0.01 dB between d.c. and 50 Mc/s and perhaps higher.

High-speed Tape Transport

MAGNETIC tape speeds of 2,500 cm/s (1,000 in/s) or more, allowing recording of signals with bandwidths in excess of 10 MHz, are claimed for a new type of tape transport recently made available to manufacturers of audio/visual, instrumentation and data processing equipment. Developed by Newell Associates Inc., of Sunnydale, California, U.S.A., the mechanism also permits higher accelerations and decelerations than in conventional transports ("several thousand" in/s²), can be reversed very rapidly (in 80 ms at a speed of 300 cm/s (120 in/s), for example), and permits recording tracks to be packed as closely as 100 per inch of tape.

These high performance figures all result from the fact that during operation the tape becomes rather like the coating on a magnetic drum—solidly supported and accurately positioned (relative to the recording/replay heads) on a rotating cylinder—instead of being an open web running through various pulleys, capstans and guides. Furthermore, in the Newell system the tape does not have to function as a mechanical power coupling element as well as a recording medium. Consequently it is not subject to the varying forces, tensions and displacements that normally cause wow and flutter, and it does not set a limit on the accelerations that can be obtained. Instead the mechanical power is conveyed by a much more rigid and compact system, as shown in Fig. 1. A motor drives the central capstan-drum, which, besides carrying the tape round part of its periphery past the head, bears firmly on the two rolls of tape and causes them to rotate in the required directions. The firm pressure on the rolls prevents the entrapment of air between the tape layers and results in a very dense pack which does not require the usual reel flanges—thereby reducing inertia and further assisting acceleration. The good acceleration performance, of course,

means that less tape is used in reaching a given speed than in a conventional transport.

It is because the tape/head positioning is precisely controlled, and because there are none of the tape-edge-guiding problems which normally arise at high speeds, that a large number of tracks can be recorded across a given width of tape.

Literature Received

Publications MQ/237X **Quartz Crystals**, H.F. **Crystal Filters**, and MF/213X **Selenium Rectifier** are data summaries from the STC Components Group, Edinburgh Way, Harlow, Essex. The first 16-page summary presents information in tabular form on low- and high-frequency miniature quartz crystal assemblies, in various mountings, plug-in assemblies, and triple crystal units for frequency control of f.m. tuners. High-frequency crystal filters include band-pass and channel spacing filters for communications. The second summary is a 21-page technical outline of rectifiers for radio, television, h.t. and e.h.t. and low-power rectifier assemblies. WW 323 for further details

About 30 leading manufacturers are represented by over 52 types of industrial electronic components in the 1967-8 **D.T.V. Group Catalogue**. The 250 pages include full technical specifications for many products including test equipment, relays, transformers, power supplies, switches and lamps. In one section, industrial semiconductors from a particular manufacturer can be selected by three charts which display detailed information on collector voltage, total dissipation, and cut-off frequency respectively. D.T.V. Group, 126 Hamilton Road, West Norwood, London, S.E.27. WW 324 for further details

Aerials—for u.h.f. and colour transmissions—produced by Belling-Lee Aerials Ltd. are described in their 1968 catalogue. This publication is supplied with a quick-reference wall chart, aerial component booklet, and price list. Areas covered by BBC-2 transmitters are shown on a map with starting dates for colour transmissions, and a list of local u.h.f. relay stations. Belling-Lee Aerials Ltd., Heysham Road, Netherton, Bootle 10, Lancs. WW 325 for further details

Product News 70102 published by Cambridge Thermionic Corporation, 445 Concord Avenue, Cambridge, Mass. 02138, U.S.A., deals exclusively with the design and selection of Cambion terminals and discusses terminal troubles on printed circuit boards. This six-page folder includes reference charts on punches and anvils for mounting various terminals, standard nomenclature for solder terminal parts, plating selection, and the properties of insulating materials used in insulated terminals. The address of the U.K. subsidiary is Cambion Electronic Products Ltd., Cambion Works, Castleton, Near Sheffield, Yorks. WW 326 for further details

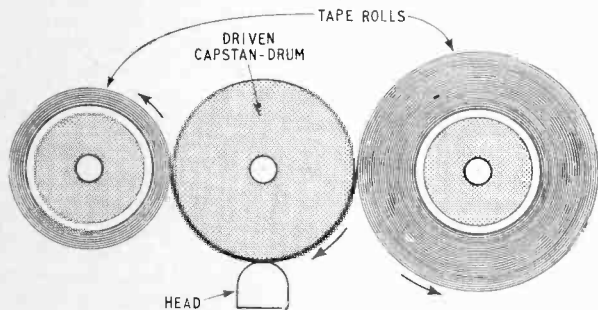

Fig. 1. Principle of the high-speed tape transport.

WIRELESS WORLD DIGITAL COMPUTER

5.—Operation of the machine. Worked examples showing how the instruction code is used in a variety of arithmetical problems

THROUGHOUT the construction and testing of the computer the reader will have become very familiar with its circuits and the method of operation; therefore little need be said about the basic arithmetic operations, with perhaps the exception of division. Several numerical examples will be given to illustrate how the computer may be used to carry out more complex tasks. The reader is advised to perform these on the completed machine as they are explained, and the reasons for the various operations will then become obvious. All control instructions will be written in their octal form.

Consider $85_{(10)} \div 15_{(10)}$, which is $01010101_{(2)} \div 00001111_{(2)}$. Referring to the control orders table (Oct. issue, p. 489), the first instruction is $022_{(8)}$. The counter now holds $00000101_{(2)} = 5_{(10)}$ and the accumulator holds $1111011_{(2)} = -5_{(10)}$ as one too many subtractions have taken place and the carry store is set. The next instruction is $040_{(8)}$. This resets the carry store. The third instruction is "add" (to compensate for the one too many subtractions), that is, $001_{(8)}$. The accumulator now holds $00001010_{(2)} = 10_{(10)}$, which is the remainder, and once again the carry store is set, necessitating another $040_{(8)}$ instruction. From this it can be seen that the sequence of instructions, or programme, required for the division is $022, 040, 001, 040$. The result (quotient) is then held in the counter and the remainder in the accumulator.

In the binary arithmetic "remainder" section (August issue) there was a reference to the natural binary coded decimal (n.b.c.d.) system, in which each decimal digit is represented by its binary equivalent, four binary digits being used for each decimal place. It is an easy matter to carry out conversion from pure binary to n.b.c.d. by first dividing by $100_{(10)}$ and then $10_{(10)}$. The programme for doing this is as follows:

Convert $1011111_{(2)}$ to n.b.c.d.

```

Write 10111111 in register (R).
001  This is 10111111 + 0 putting 10111111 in
      accumulator (A).
110  Clear register.
Write 01100100 in R (=  $100_{(10)}$ )

022 }
040 } "Divide" sub-routine. Counter holds
001 } 00000001 (n.b.c.d. 100s); accumulator holds
040 } 01011011 (remainder).

131  Transfer counter (Cntr) to St.1. (St.1 holds
      n.b.c.d. hundreds).
330  Clear counter.
110  Clear register.
Write 00001010 in R ( $10_{(10)}$ ),

```

```

022 }
040 } "Divide" sub-routine. Counter holds
001 } 00001001 (n.b.c.d. tens).
040 } Accumulator holds 00000001 (n.b.c.d. units).
132  Transfer Cntr to St.2 (n.b.c.d. tens).
123  Transfer A to St.3.
330  Reset Cntr.
110  Reset R.

```

The contents of the stores are now as follows.

```

St.1. 00000001      St.2 00001001      St.3. 00000001
      =  $1_{(10)}$           =  $9_{(10)}$           =  $1_{(10)}$ 

```

Only four bits are required for n.b.c.d. representation; therefore $1011111_{(2)} = 191_{(10)} = 0001\ 1001\ 0001$ (n.b.c.d.).

The computer can be used to carry out the reverse operation, n.b.c.d. to pure binary. This is done by multiplying by $100_{(10)}$ and $10_{(10)}$ and adding as follows:—

Convert 0001 1001 0001 to natural binary

```

Write 01100100 in R ( $100_{(10)}$ ).
111  Transfer R to St.1. (St.1 holds multiplier).
Write 00000001 in R (n.b.c.d. hundreds).
011  Multiply.
330  Clear counter.
122  Transfer A to St.2. (storing result until re-
      quired).
110  Clear R.
Write 00001010 in R ( $10_{(10)}$ ).
111  Transfer R to St.1 (St.1. holds multiplier).
Write 00001001 in R (n.b.c.d. tens).
011  Multiply.
212  Transfer St.2 to R. (R now holds result of first
      operation).
001  Add (A now holds combined results of first and
      second operation).
110  Clear R.
Write 00000001 in R (n.b.c.d. units).
001  Add. (A now holds result, 1011111(2)).
Finish off the programme by tidying up the
computer:—
110  Reset R.
330  Reset Cntr.
101  Reset St. 1.

```

We have converted 1011111 to its n.b.c.d. form and back again. Now what about operations in pounds, shillings and pence?

POUNDS, SHILLINGS AND PENCE

Let us add £4 11s 6d, £39 7s 8d and £17 14s 3d. The method to be adopted here is to deal with the pence

first, then the shillings and then the pounds, as is standard practice. For the sake of clarity, in this example, the quantities will be retained in their decimal form, but the constructor will, of course, convert them to binary for feeding into the computer.

_____ Write 6 in R.
 001 Add.
 110 Clear R.
 _____ Write 8 in R.
 001 Add.
 110 Clear R.
 _____ Write 3 in R.
 001 Add.
 110 Clear R (Total pence now held in R).
 _____ Write 12 in R.

022 }
 040 } "Divide" sub-routine. Pence held in A;
 001 } shillings in Cntr.
 040 }



132 Transfer Cntr. to St.2. (Shillings temporarily held in St.2).
 Clear Cntr.
 330 Transfer A to 1 (pence held in St.1.).
 121 Clear R.
 110 Clear R.
 222 Transfer St.2 to A. (Carry shillings from pence addition).
 _____ Write 11 in R.
 001 Add.
 110 Clear R.
 _____ Write 7 in R.
 001 Add.
 110 Clear R.
 _____ Write 14 in R.
 001 Add. (Total shillings now held in A).
 110 Clear R.
 _____ Write 20 in R.

022 }
 040 } "Divide" sub-routine. (Shillings held in A
 001 } and carry pounds in Cntr.).
 040 }
 110 Reset register.
 133 Transfer Cntr. to St.3. (Carry pounds).
 330 Reset Cntr.
 122 Transfer A to St.2. (Total shillings now held in St.2.).
 223 Transfer St.3 to A. (Carry pounds).
 _____ Write 4 in R.
 001 Add.
 110 Clear R.
 _____ Write 39 in R.
 001 Add.
 110 Clear R.
 _____ Write 17 in R.
 001 Add. (Total pounds held in A).
 110 Clear R.
 123 Transfer A to St.3.

Total pounds are now held in St.3, shillings in St.2 and pence in St.1. The reader is invited to work out his own programmes for monetary subtraction, division and multiplication. In the addition just described the number

THE COMPUTER AT SANDHURST

The upper photograph shows Officer Cadets of the Royal Military Academy, Sandhurst, engaged in construction of the computer. The lower one was taken while senior lecturer J. B. Beecher was explaining the operation of the machine using large logic diagrams prepared by the Sandhurst drawing office from those published in "Wireless World."

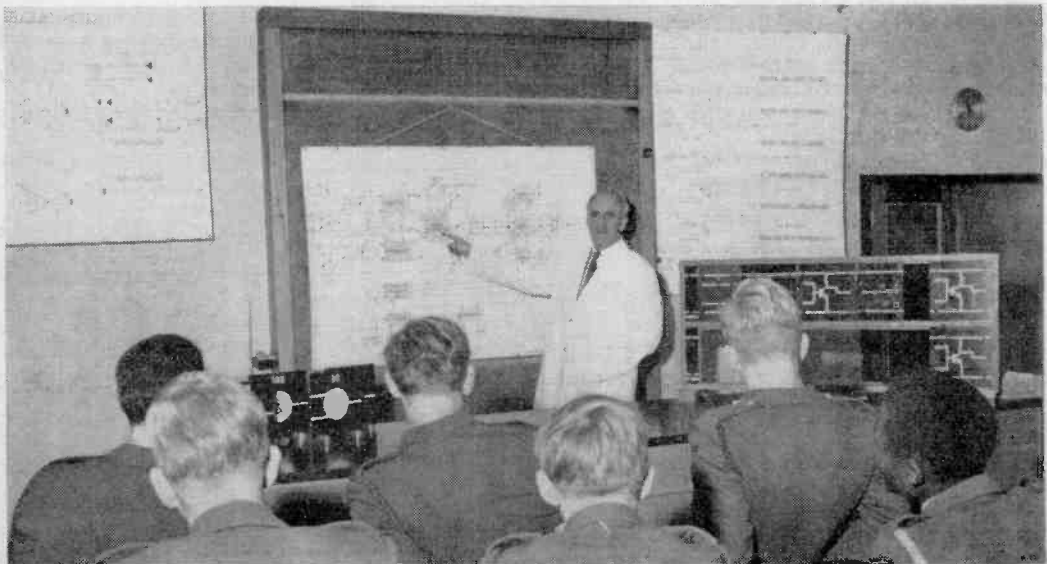

of quantities to be added need not be restricted to three so long as the capacity of the accumulator is not exceeded.

ONES AND TWOS COMPLEMENTS

To perform subtraction by the 1s complement method proceed as follows:

Using 1s complement subtract 0101011 from 10010011.

```

001 Write 00101011 in R.
045 Add (placing 00101011 in A).
110 Complement A. (No need to clear R before
this operation).
110 Clear R.
001 Write 10010011 in R.
001 Add. (Carry store is now set holding the end-
around-carry).
110 Clear R.
001 Add (adding in the end-around-carry; result
now held in A).

```

The 2s complement method may be demonstrated in a similar fashion. Using the same figures as before the programme runs as follows.

```

001 Write 00101011 in R.
045 Add.
110 Complement A. (A now holds 1s complement).
110 Clear R.
004 Write 1 in R.
001 Add. (A now holds 2's complement).
110 Clear R.
001 Write 10010011 in R.
001 Add. (Result now held in A).

```

The carry store will now be set holding an end-around-carry that is not required. Reset it (040) before carrying out any further operations.

Now try the following. Write 00000101 in R; add (001); clear R (110); write 00001010 in R; subtract (002). Clear R (110); subtract (002) to perform end-around-carry. Now let us see what we have done and analyse the results. We put $5_{(10)}$ in A and the subtracted $10_{(10)}$ so the accumulator should hold $-5_{(10)}$, but it in fact holds 11111010, which is $250_{(10)}$. But how can we tell if 11111010 is $-5_{(10)}$ or $250_{(10)}$? Now with 11111010 still in the accumulator, complement it (045); this leaves us with 00000101, which is $5_{(10)}$, showing that the complement of a negative number is, in fact, its positive counterpart, and vice versa.

Now it would be interesting to write the binary equivalents of all the numbers from +5 to -5 in 1s complement form:

```

+5 00000101
+4 00000100
+3 00000011
+2 00000010
+1 00000001
0 00000000
0 11111111
-1 11111110
-2 11111101
-3 11111100
-4 11111011
-5 11111010

```

Two facts are immediately apparent on examining this table. First, all the positive numbers start with 0 and all the negative numbers with 1; secondly, zero is represented in two ways. The first fact provides a means of telling whether a number is positive or negative. Because of this the left-hand digit is known as the sign digit, 0 indicating a positive number and 1 a negative number. Using this form of representation, the computer, instead of

operating in the range 0 to 255, now operates from +127 to -127. Using a set of rules we can now add, subtract, multiply and divide with mixed positive and negative numbers. First, though, let us prove that this table is in fact true. Write 00000101 in the register; add (001); clear R (110); and write 00000001 in the register. Now select "subtract" (002) and keep pressing the start button. The contents of the accumulator will decrease by one for each press, i.e. 5-4-3-2-1-0. On the next subtraction the accumulator will hold 11111111 and the carry store will be set. Reset the carry store (040) and continue with the subtractions. The contents of the accumulator will follow the table, -1, -2, -3 etc.

Let us add two mixed numbers long-hand and study the results, say -5 and +8.

```

  1 1 1 1 1 0 1 0   -5
  0 0 0 0 1 0 0 0   +8
  -----
1 0 0 0 0 0 1 0   +3

```

(end-around-carry).

```

  0 0 0 0 0 1 1
  -----

```

(use table in August issue to verify addition).

As we are using 1s complement representation the end-around-carry must be added. The above sum would be performed in the computer as follows.

```

001 Write 11111010 in R.
110 Add (putting 11111010 in A).
110 Clear R.
001 Write 00001000 in R.
001 Add.
110 Clear R } end-around-carry.
001 Add }

```

Result now held in A.

Subtraction of mixed signs can be performed in two different ways. First, using the "subtract" facility of the computer, subtract -5 from -8.

```

  1 1 1 1 0 1 1 1   -8
  1 1 1 1 1 0 1 0   -5
  -----
1 1 1 1 1 1 0 1   -3

```

→ 1

```

  1 1 1 1 1 1 0 0
  -----

```

(use table in August issue to verify subtraction)

Notice that the end-around-carry was subtracted. Performing this on the computer, we get:

```

001 Write 11110111 in R.
110 Add (placing 11110111 in A).
110 Clear R.
001 Write 11111010 in R.
002 Subtract.
110 Clear R } end-around-carry.
002 Subtract }

```

Result held in accumulator.

It will be remembered that adding the complement of a number is the same as subtracting it. Performing the same calculation in this manner goes as follows:

Example: 11110111 - 11111010.
First form the 1s complement of 11111010, which is 00000101, then add:

```

  1 1 1 1 0 1 1 1
  0 0 0 0 0 1 0 1
  -----
  1 1 1 1 1 1 0 0

```

which gives the same result as before. Note that no-end-

around carry occurred. A demonstration of this on the computer goes as follows:

```

Write 1111010 in R.
001 Add (placing 1111010 in A).
045 Complement A.
110 Clear R.

```

```

Write 11110111 in R.
001 Add.

```

The carry store is not set, so no end-around-carry procedure need be carried out. Result is held in accumulator ($-3_{(10)}$).

The computer will not multiply and divide numbers of mixed signs as it stands. The two basic rules of multiplication and division have to be taken into account, i.e. like signs give plus and unlike signs give minus. Numbers first have to be converted to the positive form before multiplication or division can take place by complementing only the negative numbers that are to be used. A simple set of rules is followed to give the answer the correct sign:

- (1) If both numbers are positive no corrective action is necessary. Proceed as normal.
- (2) If one number is positive and the other negative, complement the negative number and proceed with the multiplication or division and then complement the result.
- (3) If both numbers are negative, complement both and proceed with the multiplication or division. The result will have the correct sign.

As an illustration of rule (2) above we will multiply +7 by -12 showing how the computer should be operated.

```

Write 11110011 in R (-12).
001 Add (placing 11110011 in A).
045 Complement A (A now holds 00001100 i.e. +12).
121 Transfer A to St.1. (St.1 holds multiplier).
110 Clear R.
Write 00000111 in R (+7).
011 Multiply. (A now holds the result +84. Because one of the operands was complemented the answer must be complemented—Rule 2).
045 Complement A. (A now holds the corrected result -84).
101 Clear St.1
110 Clear R
330 Clear Cntr. } "tidying up" computer.

```

Division is carried out in a similar manner using the rules given above.

FRACTIONS AND DECIMAL POINTS

So far we have only concerned ourselves with whole numbers, but our eight bits could represent 11111111 or 1111111.1 or 0.11111111. Bits to the right of the binary place have weights of decreasing powers of two:—

$2^{-1} \ 2^{-2} \ 2^{-3} \ 2^{-4} \ 2^{-5} \ 2^{-6} \ 2^{-7} \ 2^{-8}$
 0 . 1 1 1 1 1 1 1 1

The following conversion table is provided for the reader's convenience.

$2^0 = 1$	$= 1.0$	$= 1.0000000_{(2)}$
$2^{-1} = 1/2$	$= 0.5$	$= 0.1000000_{(2)}$
$2^{-2} = 1/4$	$= 0.25$	$= 0.0100000_{(2)}$
$2^{-3} = 1/8$	$= 0.125$	$= 0.0010000_{(2)}$
$2^{-4} = 1/16$	$= 0.0625$	$= 0.0001000_{(2)}$
$2^{-5} = 1/32$	$= 0.03125$	$= 0.00001000_{(2)}$
$2^{-6} = 1/64$	$= 0.015625$	$= 0.00000100_{(2)}$
$2^{-7} = 1/128$	$= 0.0078125$	$= 0.00000010_{(2)}$
$2^{-8} = 1/256$	$= 0.00390625$	$= 0.00000001_{(2)}$

The binary point can be placed anywhere in our eight-bit word, provided it is in the same position in all numbers used in a particular operation.

Remainders resulting from division can be worked out to any number of binary places desired though a considerable amount of programming is necessary and results must be "stored" using pencil and paper. First of all go through the working in decimal form:

```

seven into thirteen goes 1 and 6 over      = 1
seven into six won't go; put a point      = 1.
seven into sixty goes 8 and 4 over        = 1.8
seven into four won't go shift one place left
seven into forty goes 5 and 5 over        = 1.85
seven into five won't go shift one place left
seven into fifty goes 7 and 1 over        = 1.857
and so on.

```

Every time the remainder is smaller than the divisor we shift the remainder up to the next most significant position. Now we do not have a facility for shifting one place left on the computer but it can easily be done by multiplying by two, which is the same as adding the number to itself,

```

0000100
0000100 +

```

0001000 causing a shift left.

To work out $13 \div 7$ to a number of binary places on the computer, proceed as follows. In the instructions, where the word "store" is written write the result on a piece of paper, each successive result being written in the next least significant position.

Example: $13 \div 7 = 00001101 \div 00000111$

```

Write 00000010 in R.  $2_{(10)}$  for use as multiplier
for left shift).
111 Transfer R to St. 1.
Write 00001101 in R ( $13_{(10)}$ ).
001 Add (putting 13 in A).
110 Clear R.
Write 00000111 in R ( $7_{(10)}$ ).
022 Divide
040 Clear carry
001 Add
040 Clear carry } divide sub-routine.
The whole part of the answer is now held in the counter and the remainder in the accumulator. Store the contents of the counter and as the remainder is obviously a binary fraction place a point after the answer, i.e. 1.
330 Clear cntr.
112 Transfer R to St. 2. (The divisor  $7_{(10)}$  held for future use).
123 Transfer A to St. 3.
213 Transfer St. 3 to R (placing remainder in R).
011 Multiply (multiplying by  $2_{(10)}$  to shift left).
330 Clear counter.
212 Transfer St. 2 to R (placing divisor  $7_{(10)}$  in R).
022
040 } divide sub-routine.
001
040

```

The counter now holds the first binary place 2^{-1} and the accumulator holds remainder. Store contents of counter. Result is now 1.1. Keep repeating the sequence of instructions 330, 112, 123, 213, 011, 330, 212, 022, 040, 001, 040 until the required number of binary places has been obtained or until the accumulator holds 0. It must be admitted that this whole business is rather unwieldy, but it does serve to demonstrate the process. If some form of sequential programming device were added to the machine this process could be carried out as a sub-routine requiring only one instruction.

Valediction.—This completes the series of articles on the computer. It is hoped that readers who have not

constructed the machine have been able to obtain some useful information from the series. It is also hoped that those readers who have built the computer have surmounted any difficulties that may have arisen and are now basking in the sense of achievement that results from constructing a unit of this complexity.

CORRECTIONS: (1) FIG. 14. Outputs of bistable 1 should be labelled OUT and OUT not 2 and 1 as shown. (2) Fig. 32. A 4.7k resistor should be connected in series with the meter and the battery connections should be reversed—negative to meter.

COMBINED COUNTER/REGISTER CIRCUIT

It has been suggested by a reader, D. A. Ellis, that if a combined counter/shift register could be developed then it would be possible to effect serial transfers from the counter, rendering the counter transfer gating unit redundant. Such a unit is described here. It should be noted, however, that a number of modifications would be necessary to the basic computer decoder, these are not described. Those readers that have understood the operation of the computer should be able to incorporate this circuit without too much difficulty—if they so desire.

The basic bistable of Fig. 11(a) (August issue page 371) is modified as per Fig. 1, a pair of set and reset (a.c.) outputs being provided. If these bistables are connected as in Fig. 2 and the COUNT inputs are down then the bistable chain will count any pulses fed to the input p(1). If the COUNT inputs are up the chain will ignore any pulses present at p(1).

Now if the bistables are connected as shown in Fig. 3 and the COUNT inputs are up and shift pulses are applied to the p(2) inputs a shift register results. Also if the COUNT inputs are down the chain behaves as a counter, counting pulses applied to p(1).

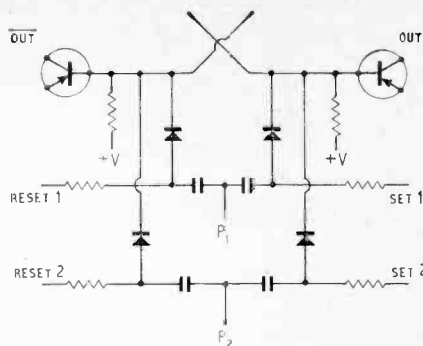

Fig. 1.

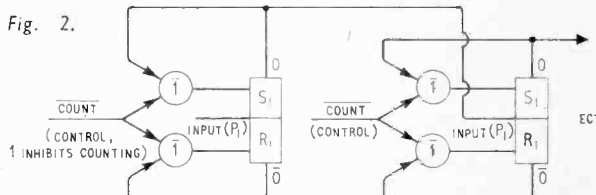

Fig. 2.

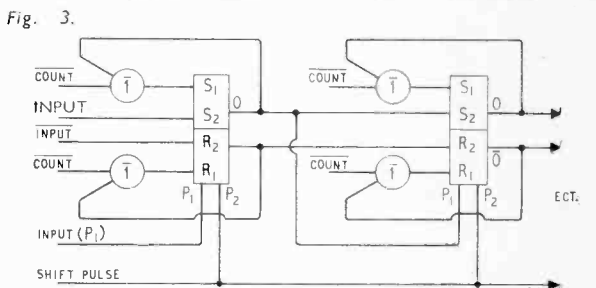
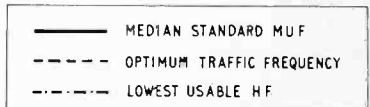
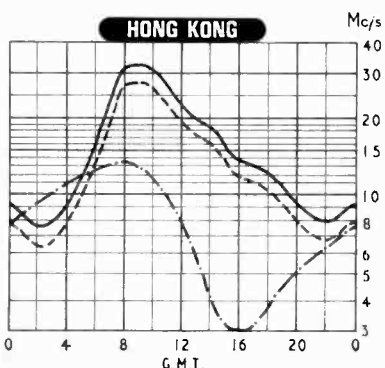
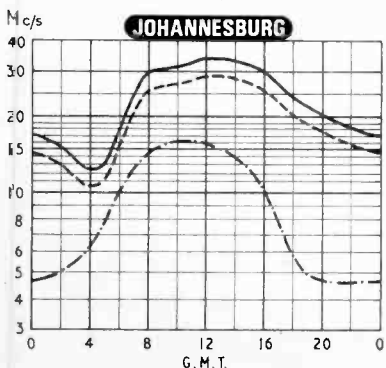
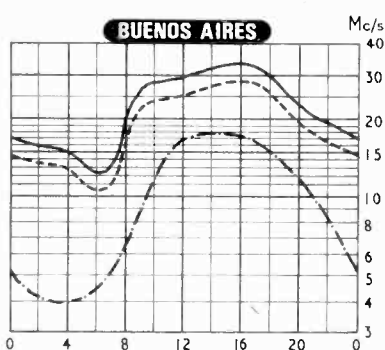
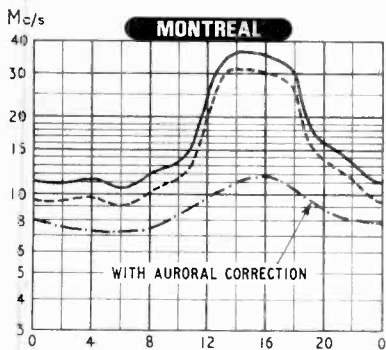

Fig. 3.



H. F. PREDICTIONS —DECEMBER

The curves show median standard maximum usable frequencies (MUFs), optimum traffic frequencies (FOTs) and the lowest usable frequencies (LUFs) for reception in the U.K. Communication for more than 90% of the month should be possible if working frequencies are below FOT and above LUF. Hong Kong curves indicate that these conditions cannot be met from midnight to 06.00 G.M.T. The LUFs shown are calculated for particular point-to-point telegraph circuits but will also apply for broadcast reception. LUFs for the amateur service will, due to much lower e.r.p., be several Mc/s higher.

Sunspot and magnetic activity over the past few months have been at a low level. Extended use of frequencies above 20 Mc/s is not as general as during the corresponding period of the last sunspot period.

LETTERS TO THE EDITOR

The Editor does not necessarily endorse the opinions expressed by his correspondents

“Radio Amateur’s Improvisation”

I HAVE held a transmitting licence for less than ten years, but my active interest in amateur radio as a hobby extends to more than 45 years. I still derive pleasure and education in designing and constructing equipment, yet I must confess I could not agree more with the implication of the remark in the last paragraph of the report on the Amateur Radio Exhibition, p. 536, November issue.

If, indeed, the days of improvisation by amateurs are numbered, the trend is more likely to be the result of what seems to be a policy of deliberate discouragement in some commercial quarters rather than waning enthusiasm by the amateur fraternity.

Requests for information are an even greater hazard, for such approaches are more often ignored than answered. I wrote to an organization on July 24th asking

if some ferrite pot cores I have, had the same characteristics as a type I knew were made by the manufacturer concerned, for though they had a different type number they appeared to be physically similar. On September 15th I wrote again, referring to my previous letter, repeating the question and asking if they could give me an answer. To date there is no response from them, so after *three months* I am no further forward and have not even the courtesy of an acknowledgement to show for my trouble and my 8d postage. I suppose the nature of my enquiry revealed that I am only one of those tiresome amateurs messing about, improvising with “junk” instead of buying new.

W. E. THOMPSON (G3MQT)

St. Leonards-on-Sea,
Sussex.

Motor Speed Control

I FOUND Mr. Butterworth’s article (September issue) on motor speed control very helpful in furthering my own attempts to run tape decks and other instruments at slow speeds. I required a circuit which would run from a single battery and with as little as possible extra current consumption. I propose the following arrangement as an extension of Mr. Butterworth’s design.

Since the differential stage must have a “long tail” to give good common mode rejection, a complementary system was chosen (Tr1 and Tr2) thus avoiding an additional constant current transistor and halving the standing current which would otherwise be required. The stage is also self adjusting, in this case to the value of collector current demanded by the constant current source Tr3. The latter was chosen to reduce the effect of supply voltage change but it also gives a useful increase

in loop gain. I have found that the capacitor C_1 is necessary to prevent high-frequency oscillation.

Speed variation is obtained by setting the current source Tr6 to give an output which will develop the required voltage across R_1 (the bridge arms in which the motor is placed are of too low a resistance for this purpose). With the use of a Zener diode and the current source Tr3 already mentioned, the motor speed is almost independent of supply variations of $\pm 20\%$.

The circuit was tested using a 9-volt Garrard motor having a d.c. resistance of 16 ohms. It was run at 2 V to give about one-third the nominal speed which it maintained under load within a few per cent until the drive has reached saturation at 6 V. The total current drain off load is 50 mA, only 2 mA being required for the additional circuitry.

N. BETT

Cavendish Laboratory,
Cambridge.

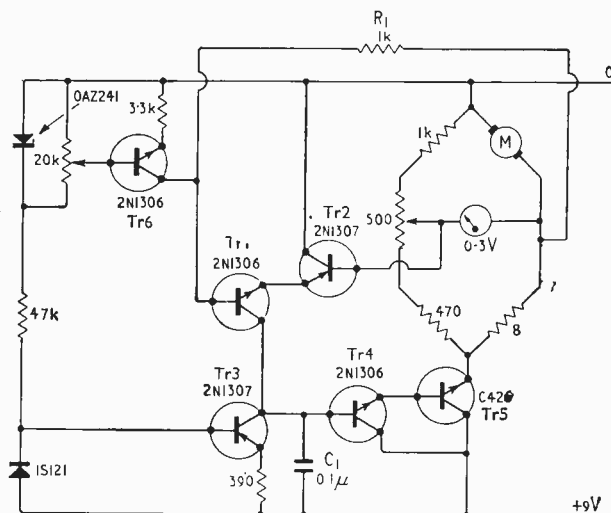

Using Integrated Circuits

THE purpose of my original article in the July issue on the use of a digital i.c. in a stereo mixer and pre-amplifier was to establish the fact that the time had come to design apparatus on the basis of economy, since it can be taken that the performance of equipment using integrated circuits will be similar to that possible with discrete components in the same price range. The form taken by the correspondence has tended to obscure this point. Mr. Short points out that since the discussion began, the price of discrete components has fallen. That may be so, but developments in the field of integrated circuitry are little short of explosive. Though the text of my original article was completed in late February this year, already there are developments going much beyond it. At that stage it was necessary to adapt an i.c. originally designed for logic functions, accepting a few limitations, and

incidentally achieving a surprising degree of success considering the extent to which the operating conditions were modified. At the moment, however, there has been such a growth in the range of i.c.s produced, that it is possible to obtain linear i.c.s for practically every application, including low noise amplification, and price reductions are frequently announced on established lines. Therefore I consider it a rather dangerous position to adopt, to continue to defend discrete components on grounds of cost. At the same time there is no doubt that they will retain a place in the field of electronics, due to their flexibility.

Washington, D.C.

A. J. McEvoy

“Lighten Our Darkness . . .”

ALTHOUGH electronics people seem keen to use the international m.k.s. units in their own field, they fall down badly when they move outside it. Just lately we obtained data on closed circuit television equipment and found that some people think in foot-lamberts, others think that foot-candles are “brightness” when they are really illumination, but nobody uses metric units. I can understand people fighting shy of the m.k.s. brightness unit (luminosity unit in scientific terms) since it is called the Nit, but you would think they knew that illumination and brightness were not the same.

All our terms and units get changed about once every fifteen years. The scientists say this is because of the march of progress, but I strongly suspect the real intent is to confuse the older academic scientists and make them retire promptly!

Bolton, Lancs.

P. C. SMETHURST

Electronics and Road Accidents

BOTH your contributor “Vector,” in his article “Thoughts from a lay-by” (September issue), and your October correspondent Mr. S. Penoyre, of the Road Research Laboratory, appear to have accepted the false premise that road accidents are due to the misjudgments and weaknesses of normal people, when, in fact, all the evidence points the other way.

During the four decades in which I have been driving I have witnessed innumerable incidents in which drivers—usually private car drivers—have deliberately and callously endangered other road users when all they need have done to avert the danger was to ease back the accelerator or lightly apply their brakes.

A book, written by the late Earl of Cottenham (the man responsible for organizing the Metropolitan Police Driving School) has a chapter headed:—“Permanently Dangerous Drivers,” in which the author quotes the number of people admitted to mental hospitals during the year preceding that in which he writes (1932), and goes on to remind the reader that for every person definitely insane and under surveillance, there are probably ten on the border-line; people who, although not insane, are mentally unstable and predisposed to be unsafe in charge of a car. It is people like these—people who, judged by any reasonable standards, ought never to have been issued with driving licences in the first place—who cause most of the serious road accidents; not normal reasonable people temporarily upset by personal worries.

All the electronic equipment in the world can never

make motor vehicles safe in the hands of fools, rogues and lunatics: and if “Vector” and Mr. Penoyre wish to serve the cause of road safety, I suggest that they forget electronic aids to driving, study Dr. T. C. Willett’s book “Criminal on the Road,” and devote themselves to doing all they can do to convince the Minister of Transport of the need to stop the indiscriminate issue of driving licences.

J. A. LANE

Kenton, Middx.

Aerial Efficiency

WITH reference to the article in your September issue by Mr. Towers, we feel that this leaves rather a vague situation on the subject of aerial directivity. Although there may be a certain amount of variation in the characteristics of aerials of different manufacture, it must be remembered that the entire plan for u.h.f. television in this country depends upon certain agreed minimum standards which were reached by aerial manufacturers before the plan was produced. Without these minimum standards the whole u.h.f. service in this country would collapse.

With regard to channel grouping we feel that Mr. Towers has given too much emphasis to colour coding (which is largely for manufacturers’ internal convenience). The letter coding, i.e. groups A, B, C, D and E, are used by the B.B.C. in all of their publicity without reference to colour codes.

P. STALLWORTHY
(Product Group Manager)

Antiference Limited,
Aylesbury, Bucks

IN his article in the September issue about aerials for colour TV reception Mr. Towers gives us good advice—to use “the highest-gain, most efficient aerial practicable.”

I wonder how many readers of forty years’ standing like me were reminded of the exhortations of long ago, that whatever we did with our “breadboard” sets, to settle for nothing less than our full (legal) hundred feet of aerial down the garden!

G. W. M. LUSH

Gaydon, Warwick

Multum in Parvo

THE 80-page reference section of the 1968 *Wireless World* Diary includes the majority of the sections which, over the years, have been found to be most useful but, of course, they have been brought up to date and in many cases extended. The list of transistor near equivalents now occupies nine pages; fuller details are given of the B.B.C. PAL colour television signal and there is a new section on stereo reception. The circuit diagrams in this edition (the 50th) include a stereo decoder, discriminator, and pre-amplifier. The contents extends from addresses of radio and electronic organizations (both national and international) to World television standards, through circuit elements, formulae and symbols.

The Diary, measuring 4×2½in, and giving a week-at-a-opening, costs 9s in leather and 6s 6d in rexine (including purchase tax). Overseas prices are 7s 7d (leather) and 5s 6d (rexine). Copies are available from booksellers or by post (4d extra) from our publishers Dorset House, Stamford St., London, S.E.1.

NEWS FROM INDUSTRY

ELLIOTT HEAD-UP DISPLAY BREAK-THROUGH

THE Ling Temco Vought Aero-space Corporation of America has awarded Elliott-Automation a contract worth \$40M over the next four years for head-up display systems. Elliott-Automation will be one of six sub-contractors supplying equipment that will result in a fully digital integrated aircraft control and instrumentation system. Other sub-contractors will be supplying the doppler radar, the inertial navigator, the forward-looking radar, and the air data computer; the functions of all these systems will be combined and integrated in a special-purpose digital computer to be supplied by I.B.M. The complete electronic system can be considered to be a "mini" version of the I.L.A.A.S. (Integrated

Light Aircraft Avionics System) developed by the Sperry Company for the United States Navy for which Elliotts were also awarded the head-up display equipment contract. I.L.A.A.S., however, remained an experimental project. The new system, that is the subject of this contract, will be installed in the Corsair A7D and A7E aircraft intended for the United States Air Force and Navy and it is expected that 1,000 of these aircraft will be built. The Elliott head-up display will consist of attitude and instrumentation data projected on the aircraft's windshield, from a ceramic cathode-ray tube, and focused at infinity. So no matter where the pilot's eyes are focused the display will still be in focus.

I.C.T. LAUNCH A LARGE e.c.l. COMPUTER

I.C.T. have announced a new very large computer, the 1906A, which will be suitable for scientific and commercial users. The machine costs between £0.5M and £1.5M and is the largest machine fully committed for production by a British manufacturer. The use of non-saturating emitter coupled logic (e.c.l.) enables very high speeds to be achieved. The actual processing time varies and depends on the degree of store interleaving, the position of instructions and operands, and the sequence of preceding and following instructions. Typically a mix of commercial routines containing 875 instructions is executed in 900 μ sec. The floating point arithmetic unit will add and subtract in 900 ns, multiply in 2.6 μ sec and divide in 7 μ sec. Each floating point number is held in two consecutive words in the format, exponent—eight bits plus sign and mantissa—thirty-seven bits plus sign. An optional precision floating point unit is available

to operate on numbers held in four consecutive words, in this case the mantissa occupies sixty-nine bits plus sign. The paging system originally developed for Atlas is also available as an optional extra; this is a method of organizing the storage of information to make more flexible use of core and drum storage and to give greater flexibility of programming. The integrated logic is mounted on twelve layer circuit boards with plated through holes. Of the twelve layers, three are for power, one for power logic, two are for earth and transmission-line earth connections, four are for logic and the remaining two contain the sockets for integrated circuits and external wiring. The e.c.l. logic employed was designed by I.C.T. in conjunction with Motorola. Readers may be interested to note that *Wireless World* hopes to publish two articles on the design emitter-coupled, emitter-timed, monostable and astable multivibrators in the near future.

MARCONI HEADS A SIX-NATION EUROPEAN CONSORTIUM

AN air traffic control contract (€1M) was signed in Brussels recently between Eurocontrol and a six-nation consortium headed by the Marconi Company. The consortium consists of three main members each associated with a principal sub-contractor. These are the Marconi Company (U.K.) with Philips Telecommunications Industry (Netherlands) as sub-contractors; Standard Elektrik Lorenz (Germany) with Standard Radio and Telefon (Sweden) as sub-contractors; and SAIT (Belgium), the principal sub-contractors in this case being the Compagnie Internationale pour L'Informatique (France). These firms, under

the terms of the contract, will provide an experimental data processing system that will pave the way for a scheme coordinating air traffic handling throughout a major part of Western Europe. The system will be built at the Eurocontrol Experimental Air Traffic Control Centre at Bretigny, near Paris, and will use a Marconi Myriad II computer with an associated French machine. The techniques developed in this experimental system will provide experience that will be used in the world's first international upper area control centre that will be built by Eurocontrol at Maastricht in Holland.

A process for direct "writing in" of interconnections and resistors on a thin-film substrate has been developed at Harlow by Standard Telecommunication Laboratories. The process is currently being evaluated for production at the S.T.C. film circuit unit at Paignton. The starting point of the operation consists of a glass substrate on which a layer of nichrome followed by a layer of gold has been deposited. The substrate is placed under a specially developed stylus on a paper-tape-controlled micro-positioning table; the tape having been previously prepared by a computer fed with the relevant design information. The substrate moves under the stylus and the interconnection pattern is formed in etch resistant ink. The ink is hardened and the substrate is selectively etched to remove the gold not coated with resist leaving the underlying layer of nichrome unaffected. This first process is then completed by removing all traces of the resist. A resist pattern is now formed on the exposed nichrome and once again a selective etching process is carried out, this time only removing nichrome and not gold. The remaining nichrome strips are then converted to resistors with a typical tolerance of $\pm 5\%$. Line widths of down to three thousandths of an inch have been achieved with these methods.

Nexus Research Laboratories Inc., American manufacturers of operational amplifiers, have opened their own U.K. sales office at 81, North Street, Chichester. This move follows the recent collapse of the Livingston Group who used to handle these products.

The range of **precision phase measurement equipment** manufactured by Ad-Yu Electronics Inc. of Passaic, N.J., U.S.A., previously handled by the Livingston Group, will now be marketed in the U.K. by B & K Instruments Ltd., 59, Union Street, London, S.E.1.

The managing director of **Stow Electronics Ltd.**, a small group of companies consisting of Startronic Ltd., Technical Encapsulations Ltd., and Digitizer Techniques Ltd., opened a new factory at Hastings in October. Seven years ago the company started with Technical Encapsulations Ltd. with an annual turnover of about £100, since then turnover has doubled each year. The function of Technical Encapsulations is self-explanatory, Startronic manufacture power supplies and temperature measuring devices while Digitizer Techniques are mainly concerned with switches and digital printers.

Semiconductors manufactured in Japan by the Sanyo Electric Co. Ltd. are now available in this country from Photain Controls Ltd., Randalls Road, Leatherhead, Surrey. The range includes competitively priced transistors, diodes, varicaps, zeners and thermistors. A catalogue giving complete data is available from Photain Controls.

BEHIND EVERY **BRIMAR** OSCILLOSCOPE TUBE ...AN UNRIVALLED PERSONALISED SERVICE

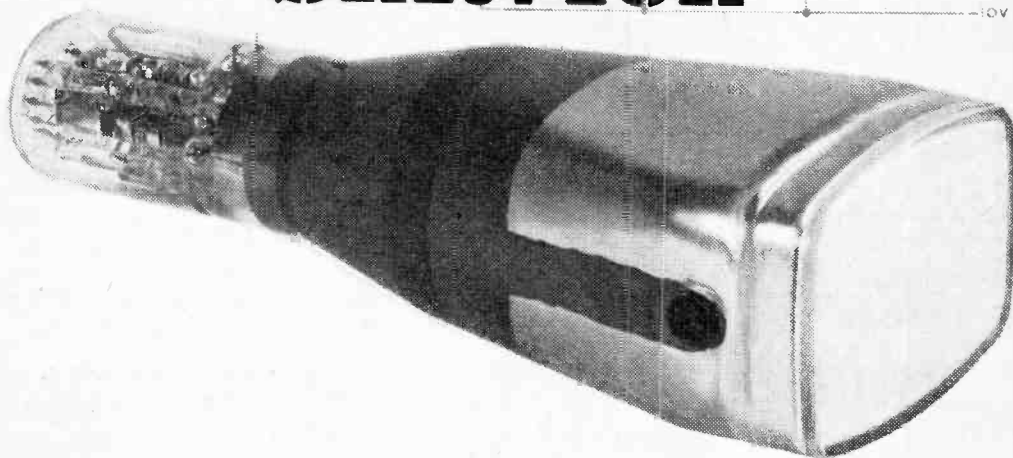

There's a BRIMAR tube to meet the needs of every oscilloscope designer—ranging from general purpose tubes of medium bandwidth to tubes designed specifically for exacting applications requiring features such as short length, wide bandwidth or dual phosphors. Face plates range from 8½" large displays to 1" types for numerical and indicator presentations including the latest 7 x 5 cm rectangular size.

PERSONALISED TECHNICAL SERVICE

Every BRIMAR oscilloscope tube is backed by a first-class technical service and assistance on any type of problem involving it—from special characteristics to circuit design. BRIMAR engineers are always available—contact is on a personal level. Just phone or write.

The BRIMAR D13-51GH is a modern Mesh P.D.A. 6 x 10 cm²-area tube, which gives improved brightness, higher deflection sensitivities and higher ratios of screen to deflector voltage with no shrinkage of raster area. The D13-51GH displays single phenomena up to 30 MHz bandwidth and is suitable for use with transistorised circuits. It needs fewer control voltages than other mesh tubes. Length is only 13¼".

We shall be pleased to let you have full details of the BRIMAR D13-51GH and the rest of the interesting range of BRIMAR industrial cathode ray tubes.



Thorn-A.E.I. Radio Valves & Tubes Ltd.
7 Soho Square, London W1. Telephone: 01-437 5233

WW-119 FOR FURTHER DETAILS

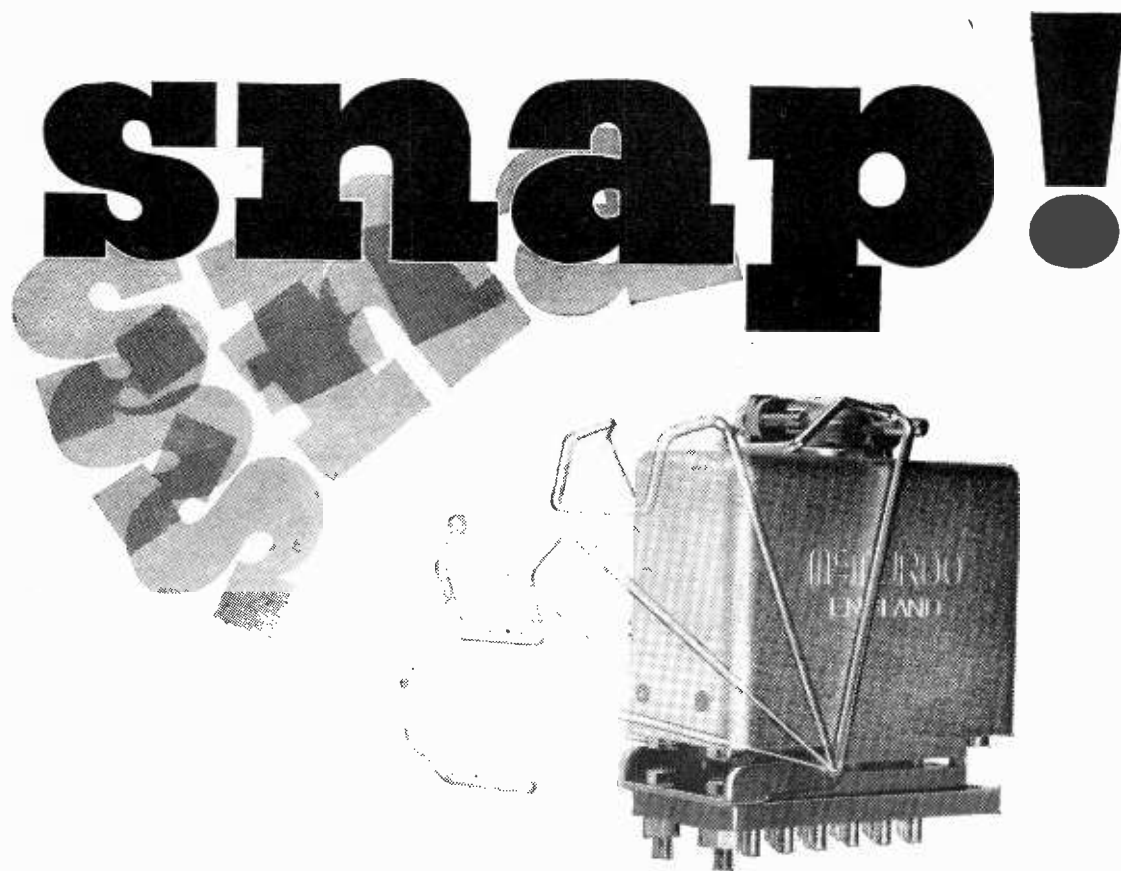

McMurdo standard connectors team up with heavy-duty latches for two good reasons

Thinking of easier accessibility and stronger latching for your connections? Snap – so are McMurdo! And we've come up with *heavy duty latches* on our *standard connector* range to give you just that with 8 to 25 ways. The strong metal cover and cable grip ensures superior electrical protection – while the steel spring clip just snaps over for tight latching . . . snaps off for easy checking and maintenance work! McMurdo *standard connectors* and *heavy duty latches* are two of a kind for longer, stronger service!

Standard connectors with heavy duty latches are more advanced than the 'XL' type of latching device – and are prefixed 'SCR' followed by the number of ways of the connector – e.g. SCR 18.

Write now for the full facts to:

MCMURDO
ELECTRONIC COMPONENTS

TECHNICAL SALES DEPARTMENT,
THE MCMURDO INSTRUMENT COMPANY LTD.,
RODNEY ROAD, FRATTON, PORTSMOUTH.
TEL: PORTSMOUTH 35361 • TELEX 86112

LUGTON & CO. LTD., 209/210 Tottenham Court Road, London, W.1. Tel.: Museum 3261. SASCO, P.O. Box No. 20, Gatwick Road, Crawley, Sussex. Tel. phone: Crawley 28700 (also: Chipping Sodbury 2641, Cumbernauld 25601, Hitchin 2242).

FRANCE: Henri Labesse. 10 Avenue Benoit Levy, SAINT MANDE. SEINE GREECE Photis S. Ulkerogiou, 38 Anatis & Agh. Saranta St., Oikiamos Papaghou. ATHENS HOLLAND Impag N/V, Minervalaan 82 hs AMSTERDAM Z.

WW-120 FOR FURTHER DETAIL

“Setting Up” a Colour TV Set

A look at the special problems in installing and adjusting a colour receiver

By T. D. TOWERS,* M.B.E.

PREVIOUS articles in this series have dealt with the main design aspects of colour television receiver practice. This final article is designed to show how an experienced technician would set about the job of installing and adjusting a colour receiver in a methodical manner to achieve the best possible performance.

PLACING THE RECEIVER

The picture on a colour set is not so bright as on a black-and-white one. You should therefore give more thought to the placing of the set in the room. Try to arrange it so that bright light, artificial or sun, does not fall directly on the screen nor is reflected on to it. Otherwise the colours can appear washed-out or even wrong in tint.

The colour set is very susceptible to stray magnetic fields. For this reason, you should never put it near radiators or similar large masses of ferrous metal. Also, beware of putting electric clocks, telephones and suchlike electromagnetic objects on the cabinet or you may find odd colour distortions arising in the picture. In the same connection, the user should be advised not to turn on or off electrical appliances like carpet sweepers close to the set. This, too, can cause spurious magnetization of the picture tube or chassis and upset the picture colour purity.

Locate the receiver at least six feet from the normal viewing position and point out that best viewing can be achieved by slightly shading the room so that the light level is a little below normal daylight. Emphasize that once the receiver has been properly installed, its position (particularly the direction it faces) should not be changed, as this can lead to colour distortion.

Once you have positioned the receiver, all that remains before you start “twiddling knobs” is to connect a suitable aerial on the lines indicated in the article on aerials, in this series, in the September issue, and plug the set into the mains.

INITIAL BLACK-AND-WHITE SETTING UP

Paradoxically, in installing a colour receiver, the first task is to set up for a satisfactory black-and-white picture. This you could do by tuning into a station putting out its pre-transmission black-and-white test pattern, but, as you will eventually need a crosshatch/dot pattern generator to set up the colour picture, you will normally find yourself using this to carry out the black-and-white adjustment, too. The black-and-white display should

be adjusted for focus, raster centring and “squaring,” the timebases, too, being adjusted to ensure correct height, width and satisfactory linearity in both directions. With a crosshatch generator this is relatively easy. The final step before going on to colour adjustments, is to set up the contrast and brightness of the black-and-white picture correctly.

Colour setting up follows five largely independent, clearly defined steps (1) degaussing; (2) purity adjustment; (3) static convergence; (4) dynamic convergence; and (5) grey scale adjustment. Sections are devoted to each of these below.

A full discussion of colour TV test equipment will be found in the article in this series in the November issue. For the work of setting up a colour set there are only two really essential pieces of equipment the degaussing coil and the crosshatch/dot pattern generator.

DEGAUSSING

Before any colour adjustments are made on a receiver, degaussing should be carried out. First make sure that the receiver is facing the way it is intended to be used. Then plug the degaussing coil into the mains and start by holding the coil near and parallel to the screen as shown in Fig. 1. Move it slowly about in small circles across the whole front of the screen and over the top and sides of the cabinet. Be careful, however, to keep

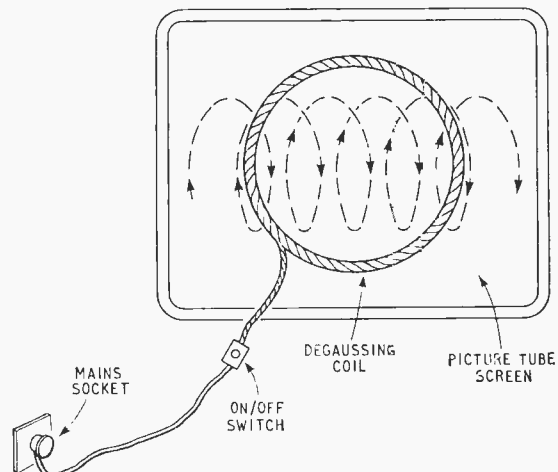

Fig. 1. How the degaussing coil is moved over the picture screen.

*Newmarket Transistors Ltd.

the coil away from the permanent magnets in the various assemblies on the neck of the picture tube. After you have gone thoroughly over the face and sides of the set, walk slowly away from the set as far as possible (and in any case at least six feet). Then place the coil flat on the floor and switch it off. Be careful not to switch the coil off while it is near the receiver. It does not matter whether the receiver is turned on or not while degaussing is going on. The whole purpose of the degaussing procedure is to demagnetize the metal shadow-mask just inside the face of the tube, as well as the metal screen covering the flare of the tube cone and the metal trim band round the screen. This way any spurious magnetism induced in them is eliminated and will not affect the colour purity.

PURITY ADJUSTMENT

In essence, good purity means that electrons from the "red" gun strike only the red-light-emitting phosphor dots on the screen, and similarly for blue and green dots and the blue and green guns. In the earlier days of colour television, small magnets attached round the outside of the screen were used to assist in achieving overall colour purity out to the screen edges. Nowadays only two main provisions exist for adjusting purity. These are the *purity magnet* (a double-ring magnet arranged round the tube so that the strength and direction of its field across the tube neck can be varied) and the *deflection yoke* (whose position along the neck of the tube controls the beam deflection centres). You can see these two components in the illustration of Fig. 2.

The purity magnet rotation controls the electrons falling near the tube axis in the screen centre and the deflection yoke position along the tube axis controls the purity away from the screen centre. Thus both must be adjusted to achieve satisfactory overall purity.

There are a number of conventional ways of adjusting purity. A fairly common one is to detach the aerial from the set, and, without applying any signal input, adjust the brightness controls so that the raster is visible. Now adjust the focus control so that the scanning lines are clearly defined. If the purity is satisfactory, the raster should be a uniform white in colour. If it is not, switch off the green and blue guns in the picture tube by shorting the appropriate grids to earth via 100 k Ω resistors and deal first with the red raster on its own. Close up the adjustment tabs of the purity magnet on

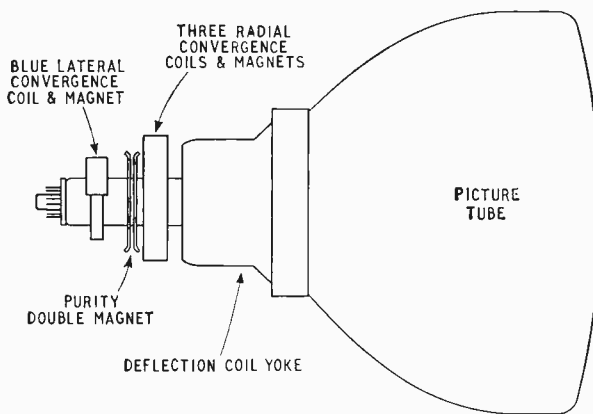

Fig. 2. Arrangement of purity and convergence adjusting components on picture tube neck.

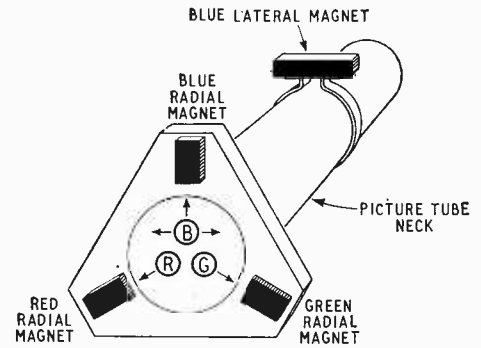

Fig. 3. How red, green and blue electron beams can be displaced by adjustment of four static convergence magnets.

the tube neck. Also, loosen the deflection yoke and move it as far back as possible on the tube neck, being careful to keep it level.

Now proceed to rotate the purity magnet round the tube neck and adjust the tabs relative to each other until the central area of the screen is a uniform red. Next push the deflection yoke carefully forward (always keeping it level) and set it in the position which gives the best overall red raster away from the centre. If the shunts on the green and blue guns are now removed, it will usually be found that the raster is a uniform white all over. This operation of adjusting the purity magnet and deflection yoke may have to be gone over several times until satisfactory purity is achieved. And it may be necessary, as a result of moving the deflection yoke about, to readjust the black-and-white picture for width, centring, linearity, etc., once again.

In setting up the purity, note that, if impurity is in the centre or on only one edge, you adjust the magnet, but, if impurity exists on both opposite edges, you adjust the deflection yoke.

Purity adjustment alone will not necessarily ensure a good colour or black-and-white picture. It ensures that the electrons in the beam from any particular gun strike only the corresponding colour phosphor dots, but it does not ensure that the individual beams are superimposed on each other properly, i.e. that the three beams move exactly in step. The individual aiming of the three beams so that for any spot on the transmitted picture they converge on the three corresponding associated red, green and blue phosphor dots is called *convergence*.

Convergence is accomplished magnetically by a system of adjustable permanent magnets forming parts of electromagnets ("convergence coils") affixed to the neck of the picture tube. Adjusting the permanent magnets converges the three beams along the tube axis close to the screen centre, while adjusting suitable alternating currents through the convergence coils controls convergence away from the centre of the screen. The central convergence is usually known as "static" or "d.c." and the peripheral convergence as "dynamic" or "a.c."

STATIC CONVERGENCE

For static convergence at the screen centre, nowadays four adjustable permanent magnets are used. Three of these ("radial convergence" magnets) are to be found (see Fig. 2) arranged symmetrically round the tube neck between the deflection yoke and the purity ring magnet as parts of the radial convergence coil assembly which lies over the three individual guns inside the tube neck.

The fourth magnet (called the "blue lateral magnet" because it moves the blue beam sideways) is located on the blue lateral convergence electro-magnet towards the end of the tube neck farthest from the screen and lying over the blue gun.

Fig. 3 gives some indication of how the individual beams are controlled by these adjustable convergence magnets. It will be seen that the red and green beams can be moved diagonally only at eight and four o'clock respectively when viewed from the front of the screen. On the other hand, the blue beam can be moved both vertically, twelve o'clock, by the front, radial convergence magnet and horizontally by the rear blue lateral magnet. The red and green beams have only one adjustment position where they cross and overlap properly at the centre of the screen. The blue beam has two degrees of freedom so that it can be brought down and across to exact overlap with the green and red centre overlap. Because of this, the normal procedure is to adjust the red and green static convergence first and follow that with the blue.

It is difficult to carry out static convergence adjustments without some form of suitable signal source that displays individual spots on the screen so that you can see the lining up of the beams on selected spots. Most workers, therefore, use a dot generator which produces a pattern of bright dots evenly spaced on a rectangular pattern on a dark background as shown in Fig. 4(a).

You can easily tell whether a receiver is out of convergence without the need for a pattern generator, because on a black-and-white programme coloured fringes show up round discrete objects in the picture.

The actual routine of static convergence is first to feed the signal from the dot generator into the aerial input, and adjust the fine tuning until the sound-colour inter-carrier beats just disappear. Now switch off the blue gun, and adjust the red and green radial magnets until the red and green dots *in the screen centre* come together to form a set of uniform yellow dots. Now switch on the blue gun, and by adjusting the blue radial and blue lateral magnets bring the blue pattern dots into line with the yellow dots to produce ultimately a pattern of uniform white dots, again at the screen centre.

Note that there is often an interaction between the different magnets, so that it may be necessary to go over the procedure several times before you ultimately achieve a field of white dots at the screen centre.

If you are using a pattern generator with too closely spaced dots, you may get a false static convergence where

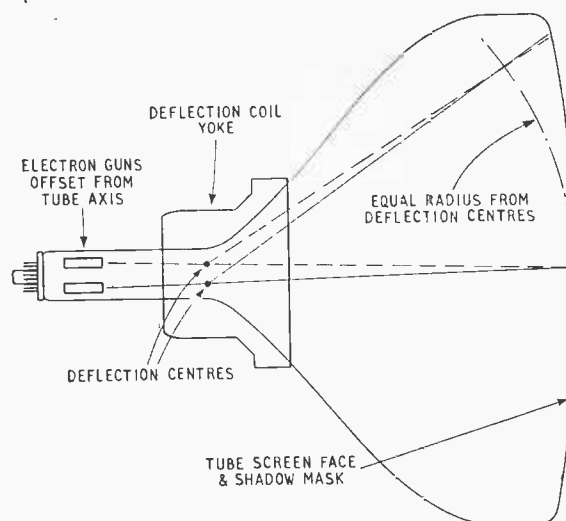

Fig. 5. Illustration of how electrons from any two guns in picture tube converge at screen centre but tend to meet short of flattened screen away from axis of tube.

one beam is displaced completely by the dot inter-spacing. This is one reason for using dot pattern generators with such widely spaced dots that it is virtually impossible to reach such a degree of misconvergence.

Static convergence ensures that the pattern dots at the screen centre are white, but away from the centre it will probably be found that the red, green and blue dots do not overlap well enough to give uniform white dots there. Dynamic convergence, described below, is necessary to clean up the pattern away from the centre.

DYNAMIC CONVERGENCE

With a nearly flat television screen, the distance between the gun deflection centres and the shadow-mask is greater at the screen edges than at the centre as shown diagrammatically in Fig. 5. In this you will see that while the beams converge properly at the shadow-mask in the screen centre, they tend to converge short of the mask at the screen edges. To maintain convergence out to the edges, coil magnets supplement the permanent static convergence magnets. Compensating currents are passed through these dynamic convergence coils in synchronism with the scanning currents so that the permanent magnet fields are opposed away from the screen centre, and the beams are thus made to converge at the shadow-mask right out to its edges.

The drive currents for these dynamic convergence coils are derived from the horizontal and vertical deflection circuits. Ideally these convergence correcting currents should have parabolic waveforms, as in Fig. 6 (a), synchronized with the horizontal and vertical sweep frequencies. However, as the three guns are not exactly along the tube neck axis but are offset symmetrically, additional correcting "tilt" currents are necessary. This tilt correction is effected by modifying the parabolic waveforms by the addition of the sawtooth components of Fig. 6 (b) to produce the composite waveform of Fig. 6 (c).

The circuitry for adjusting dynamic convergence in a colour receiver has not yet become standardized. Many different arrangements will be found in practice. At least twelve controls have usually to be adjusted, and,

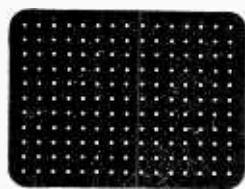

(a)

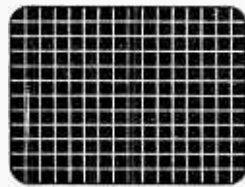

(b)

Fig. 4. Patterns commonly used in setting up a colour receiver: (a) dot (static convergence); (b) cross-hatch (dynamic convergence as well as monochrome linearity, etc.); (c) checker-board (grey scale adjustment).

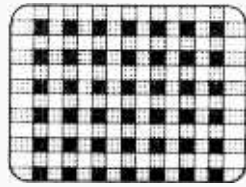

(c)

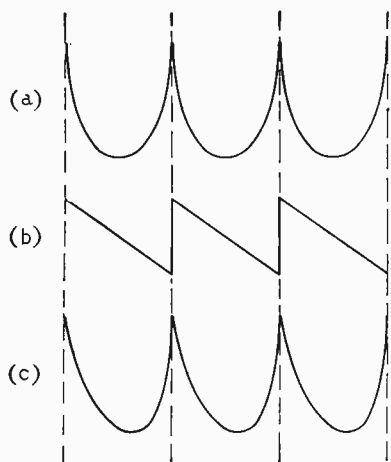

Fig. 6. Combination of (a) parabolic currents with (b) sawtooth currents in convergence coils to provide (c) required "tilted" parabolic currents for dynamic convergence away from screen centre. ■

for ease of setting up, sometimes more are found. Manufacturers use different terminology for the same controls.

Because the red and green beams are symmetrical about the vertical they are nowadays usually ganged together for initial adjustments, with separate "differential" controls for fine balance between them. The blue controls work on their own.

There seem to be two schools of thought on the order in which dynamic convergence adjustments should be carried out. One school turns off the blue gun and does the complete red/green dynamic convergence adjustment (vertical and horizontal) first, before turning on the blue gun and carrying out the blue adjustment. The other school tends to carry out the complete vertical dynamic convergence for all three colours before carrying on to the horizontal convergence. A typical convergence procedure of the first type is outlined below.

First a crosshatch pattern of white lines on a dark background (Fig. 4 (b)) is fed in from the pattern generator and the blue gun is extinguished. The separate visible red and green lines on the screen are then lined up into single yellow lines as follows by adjusting the controls specified:

- (1) R/G field parabola: bring the centre red and green verticals into line at the bottom of the screen.
 - (2) R/G field tilt: bring the centre red and green verticals into line at top and centre.
 - (3) R/G difference: bring the centre red and green horizontal lines together at top.
 - (4) R/G symmetry: brings red and green horizontal lines together at bottom and centre.
 - (5) R/G line amplitude: bring red and green verticals together on left.
 - (6) R/G line tilt: bring red and green verticals together on right.
 - (7) R/G line difference: straighten out bowing of top and bottom horizontal lines.
 - (8) R/G symmetry: reduce horizontal lines crossover.
- For the rest of the dynamic convergence, the blue gun is turned on for the following adjustments which move the blue lines in the crosshatch into the already converged yellow (red plus green) lines, to produce in the end a pure which crosshatch pattern.
- (9) Blue field tilt: converge horizontal lines at bottom.
 - (10) Blue field parabola: converge horizontal lines at top.
 - (11) Blue line amplitude: eliminate drooping of blue horizontal lines at centre.
 - (12) Blue line tilt: reduce blue horizontal line crossover.

(13) Blue line parabola: correct the undulation of the blue horizontal lines.

(14) Blue line lateral: bring blue and yellow vertical lines together on left and right.

The adjustment of purity, static convergence and dynamic convergence as explained above may sound excruciatingly complex, but it is not really as difficult as it sounds. After all, purity adjustment is merely adjusting a double ring magnet for a pure colour in the screen centre and a deflection yoke for a pure colour away from the centre. Static convergence is simply adjusting four permanent magnets on the tube neck to bring red, green and blue dots together into a single white pattern of dots. Finally, dynamic convergence is just manipulating a series of a dozen or so controls in an established sequence to bring separate red, green and blue crosshatch line patterns together into one single white crosshatch.

GREY SCALE ADJUSTMENT

Even when purity, static convergence and dynamic convergence have been properly set up, it may be found that although peak white areas in the picture are pure white, some of the grey may be tinged with colour. Adjustment is then necessary to ensure that in the scale of grey from black to peak white no significant colour cast is observed.

Some crosshatch generators have a checkerboard pattern output (Fig. 4(c)) which is useful for grey-scale adjustment. This provides black between the bars, grey on the separate bars and white at the bar cross-overs.

In early receivers as many as six or seven controls were necessary for grey-scale adjustment, and a fair bit of skill and experience was needed to carry out the adjustment. With modern circuitry improvements, it has been possible to reduce the controls to three. These are the bias voltage preset controls for the screen grids of the picture tube. With them it is possible, after adjusting contrast and brightness, to ensure that both the grey and the white in the checkerboard pattern do not exhibit traces of spurious colour.

It should be noted, however, that maladjustment of brightness and contrast controls can cause excessive picture tube beam currents which can in turn lead to severe loss of definition and contrast together with poor grey-scale tracking.

MISCELLANEOUS ADJUSTMENTS

In many textbooks you will find descriptions of "hue" and "saturation" controls, but in modern British receivers, you will probably not find these controls on the front of the set. A PAL receiver does not require the hue control basically needed by the N.T.S.C. system, because with PAL the hue is virtually constant irrespective of the phase shifts in the receiver. A saturation control tends nowadays also to be eliminated as the system of linking the contrast and saturation controls electronically has relegated it to a preset "technician's" control.

Although user controls on a colour set are being reduced to the same number as for black-and-white, a colour set is about twice as sensitive to fine tuning errors as a monochrome one. Mistuning of a black-and-white set results mainly in a loss of definition. In a colour set, even with slight mistuning the chrominance information can fade out, leaving only a black-and-white picture. A final word, therefore, might not be out of place on how to tune a colour set. A useful standard procedure is to turn the fine tuning knob fully anticlockwise and then advance it until the sound-colour intercarrier beats appear on the display and then back it off until these just disappear.

NEW PRODUCTS

equipment systems components

Motor Driven Potentiometer

THE motor-operated model V8 rheostat potentiometer has been developed by the British Electrical Resistance Company as an automatically controlled unit offering a wide range of ohmic values with scope for special variations in resistance laws. It is of particular interest where acceleration control is desired for use in conjunction with thyristor drive applications, where simple fixed speed motor drive is satisfactory. The rheostat potentiometer is totally enclosed in a dust and damp proof bakelite moulding. Up to three can be ganged. It is wire-wound, employing nickel-copper wire of negligible temperature coefficient for low ohmic values, and nickel chromium iron-free wire for higher values. All wire used conforms to B.S. 115. The brush gear has a very smooth action, and is of phosphor bronze, specially designed to ensure long life to wires of all gauges. Connection to the brush arm from the terminal is via a contact arm and collection plate. The spindle is insulated. Variation of resistance law with rotation can be obtained by the use of tapered formers combined with windings of variable pitch to obtain a logarithmic relationship between the angle of rotation and resistance. The standard 115 V a.c. synchronous pilot motor is wired through a series dropping resistor for direct connection to a 230/250 V a.c. supply. A reduction gear box is included in the design of the motor to give an alterna-

tive 1 r.p.m. or 4 r.p.m. output speed, which may be further geared through an external gearing arrangement to provide the selection of final output speeds, or traverse times. The winding consists of nickel copper wire up to 2000 Ω . Nickel chromium wire is used above this value. Resistance tolerance is standard $\pm 10\%$, and up to $\pm 1\%$ is possible by special negotiation. Linearity tolerance is $\pm 3\%$. The rating in 70 $^{\circ}\text{C}$ ambient temperature is 3 W and the angle of rotation is 325 $^{\circ}$ mechanical and 308 $^{\circ}$ effective. The British Electrical Resistance Company Ltd., Queensway, Enfield, Middlesex.

WW 301 for further details

ACTIVE FILTERS

TWO units, 5001/29 and 5002/29, are third order low-pass active filters (combining a high-gain operational amplifier and passive elements) with Butterworth and Tchebyscheff responses respectively. With these units a pass-band gain of from -6 dB to $+40\text{ dB}$, and a cut-off frequency from 5 c/s to 20 kc/s, may be specified. Frequency and gain tolerance are $\pm 1\%$ at 25 $^{\circ}\text{C}$ and frequency and gain stability are $\pm 0.05\%$ $^{\circ}\text{C}$. Input impedance is 10 k Ω minimum and the output is $\pm 10\text{ V}$ at $\pm 10\text{ mA}$ minimum. General Test Instruments Ltd., Gloucester Trading Estate, Hucclecote, Glos.

WW 302 for further details

I.C. Amplifier

ALTHOUGH designed primarily as a telephone system channel amplifier the characteristics of the SGS-Fairchild linear microcircuit $\mu\text{A}716\text{C}$ also make it suitable for audio, instrumentation, servo control and mobile communications systems. It is described as a monolithic, fixed-gain, medium-power amplifier. Voltage gains of 10, 20, 100 or 200 can be selected by the equipment designer. Minimum voltage swing is

Diode-tuned f.m. Tuner

VARACTOR diodes, d.c. voltage-tuned, replace variable capacitors, and permit remote tuning, electronic frequency scanning and sampling or fixed frequency selection through push-button or rotary switches. This new method of f.m. tuning (see *W.W.*, November 1967) which can be applied to communications, medical electronics, telemetry, sweep generators, etc., is being used by A.R.E.F. (AS Danish Radio Frequency Co.) in their f.m. domestic tuners. Two tuners are in production, the ST3 and ST4. The tuner ST4 is a four diode type intended for high-fidelity equipment and for portable and table radio receivers of above average performance. Four circuits, the aerial, two r.f. and oscillator, are tuned with the capacitance diodes instead of a variable capacitor. Tuning to stations is achieved through varying the diode bias voltages. This method offers remote station tuning, automatic scanning of dial, and station sampling. Although equipped with silicon devices it can also be supplied with f.e.t.s. The frequency range is 87.5 to 108.5 Mc/s, the i.f. is 10.7 Mc/s. The power gain at 106 Mc/s is approximately 27 dB. Noise figure is 4 dB, but with f.e.t.s it is 2.5 dB. I.f. rejection is 80 dB, and image rejection is 60 dB. Special industrial units for frequencies from 30 Mc/s to 200 Mc/s are made to request. A.R.E.F., Naestved, Aerovej 3, Denmark.

WW 303 for further details

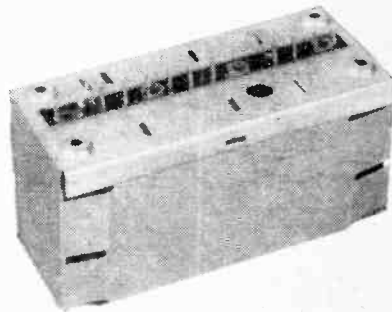

10 V peak to peak into 150 Ω load (15 V peak to peak into loads of 5 k Ω and above) permitting loudspeakers to be driven directly by the device. With a voltage gain of 100, total harmonic distortion of a typical amplifier is 0.01%, making it attractive for audio applications. SGS-Fairchild, Planar House, Walton Street, Aylesbury, Bucks.

WW 304 for further details

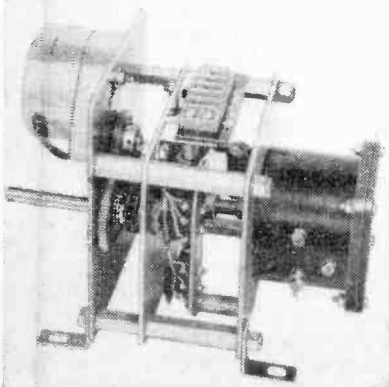

High Speed Recorder

SERVO equipment testing, analogue, computation and medical research are among the specific applications for which the twin-channel quick response recorder QU/70/R2 has been designed. Made by Evershed and Vignoles Ltd., it incorporates drawer-type interchangeable pre-amplifiers, has eight chart speeds and uses servo driven stylii to yield accurate rectilinear traces. The plug-in pre-amplifiers provide input characteristics to suit a wide variety of applications, and the writing system employed produces a clear permanent trace on electro-sensitive papers. The

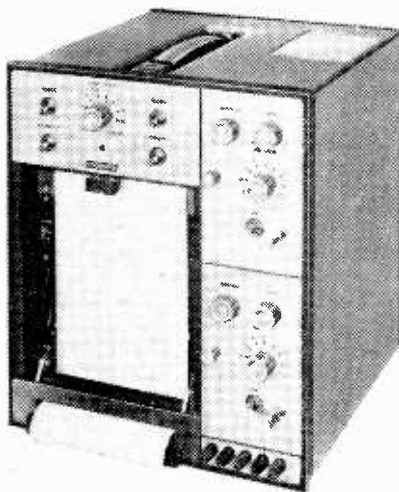

stylus is controlled by a moving coil mounted on oil impregnated bearings inside a permanent magnet. The metal stylus makes contact with the paper as the paper moves over a knife edge, producing a trace by means of a high voltage. The resetting signal for the stylus servo is produced by a rotary differential transformer connected mechanically to the moving coil. This transducer provides an accurate signal and imposes negligible inertia and friction loading on the writing mechanism. The chart speed is controlled by a d.c. velodyne servo unit which has a speed range of 30 to 1 and this servo unit used in conjunction with a two-speed gear-box gives the instrument a speed range of 1 cm/minute to 30 cm/minute in eight speed steps at an accuracy of $\pm 5\%$. Chart speed is independent of the mains supply voltage and frequency. Two event marking stylii are provided, and their action is to mark the paper in response to a two-state signal applied to the marker terminals. The time calibrator is an internal oscillator which provides accurate one second pulses as a time reference. The recorder is said to have a flat frequency response up to 60 c/s at an amplitude of 5 cm and up to 120 c/s at a reduced amplitude. Rise time is five milliseconds maximum. Instrument Division, Evershed & Vignoles Ltd., Acton Lane, Chiswick, London, W.4.

WW 305 for further details

Precision Potentiometers

SERIES 7360 and 7460 precision potentiometers with three and five turns respectively are available from Beckman Instruments Ltd., Queensway, Glenrothes, Fife, Scotland. Resistance ranges available in the series 7360 and 7460 are $10\ \Omega$ to $30\ k\Omega$ and $10\ \Omega$ to $50\ k\Omega$ respectively. Standard resistance tolerance is $\pm 3\%$, and the minimum practical resistance tolerance is $\pm 1\%$. Independent linearity for the 7360 varies from $\pm 1\%$ for less than $5\ \Omega$ to $\pm 0.25\%$ for more than $100\ \Omega$; the same parameter for the series 7460 is $\pm 0.5\%$ for less than $50\ \Omega$ to $\pm 0.25\%$ for more than $100\ \Omega$. The power rating is 1.5 W at 40°C derating to 0 at 85°C . Insulation resistance at 500 V d.c. is $100\ M\Omega$. Actual electrical travel for the 7360 is $1,080^\circ (+10^\circ/-0^\circ)$ and for the 7460 it is $1,800^\circ (+10^\circ/-0^\circ)$. These wirewound pots with $\frac{3}{8}$ in diameter are available in both standard bushing and servo mount versions, and standard two-gang units are also available. Special

features available to order include centre tap, rear shaft extension, flatted or slotted shaft, and shaft lock (bushing mounts only).

WW 306 for further details

DARLINGTON AMPLIFIER

AVAILABLE from Jermyn Industries is the General Electric (USA) D16P4 amplifier. This device is a planar epitaxial passivated n-p-n silicon Darlington monolithic amplifier, suitable for pre-amplifier input stages requiring high input impedances of several megohms. The gain at 2 mA is 7000 rising to 20000 at 100 mA. The V_{SE0} is 20 V and V_{CRO} is 40 V. This high-gain amplifier is encapsulated in the G.E. epoxy package. Jermyn Industries, Vestry Estate, Sevenpaks, Kent.

WW 307 for further details

Low-noise Amplifier

CIRCUITRY of the Brookdeal LA350B low-noise amplifier is designed to provide a good noise figure at frequencies above 1 kc/s from a wide range of source impedances—a 3 dB or better noise figure being available from impedances of 1 to $500\ k\Omega$. The noise bandwidth can be changed by the use of built-in high and low pass filters (6 dB/octave). Both of the filters have ten positions, the h.f. covering 300 kc/s to 10 c/s and the l.f. 3 c/s to 100 kc/s. Maximum gain is 100 dB, and this can be reduced in 5 dB steps by distributed feedback attenuators. The unfiltered bandwidth is 3 c/s to 300 kc/s, and non-linearity is held below 0.1% at all positions of the controls up to the full output level of 2 V r.m.s. Total harmonic distortion is less than 0.01% at 1 kc/s for the above stated output. Input impedances are $1.5\ M\Omega$ and $80\ k\Omega$ (switch selected). Brookdeal Electronics Ltd., Myron Place, London, S.E.13.

WW 308 for further details

THIN FILM POTENTIOMETER

A SUB-MINIATURE thin-film pre-set potentiometer, the TPP-TO-5 has a nickel alloy case and conforms to the TO-5 outline. Manufactured by Iskra Kranj of Yugoslavia it has a resistance track which is vacuum deposited on to the substrate. This is said to provide a component with an extremely low capacitance and inductance. The potentiometer terminals are isolated from the case and the case is internally connected to the fourth output lead, all leads are gold-plated. There are 24 values of standard ratings from $56\ \Omega$ to $4.7\ k\Omega$ (linear). Tolerances are $\pm 10\%$ standard and $\pm 5\%$ special. The noise is less than $0.01\ \mu\text{V/V}$ without rotation, and less than 20 mA rotating. Temperature coefficient is less than $\pm 50\ \text{ppm}/^\circ\text{C}$. Available in the U.K. from Guest Electronics Ltd., Nicholas House, Brigstock Road, Thornton Heath, Surrey.

WW 309 for further details



HIGH VOLTAGE REED SWITCH

WITH a uniform glass diameter of 0.130in, glass length of 0.805in and an overall length (including leads) of 2.25in, the FR-Hamlin MRO-2 high-voltage magnetic reed switch from Flight Refuelling Ltd., Wimborne, Dorset, is for use in equipment such as oscilloscopes and digital voltmeters which require switching of low-power high-voltage circuits. The MRO-2 has a maximum switching voltage rating of 1kV d.c., maximum switched current of 1mA and a maximum breakdown voltage of 2kV d.c. Price is approximately £2 each. The national distributors of this reed switch are R.T.S. Ltd., of Cambridge.

WW 310 for further details

A.C. Microvoltmeters

ALTHOUGH designated "A.C. Microvoltmeters," two new instruments from Levell Electronics Ltd. may also be used as accurate oscilloscope pre-amplifiers. Both types—TM3A and TM3B—have sixteen sensitivity ranges in 10 dB steps from 15 μ V to 500 V f.s.d. with frequencies between 1 c/s and 3 Mc/s. A feature of these solid state instruments is the facility for adjusting the frequency-response to suit special requirements, by using external reactive circuitry. In addition, the TM3B has a three-position control bringing in either of two bandwidth reducing filters. This model has also a five-inch mirror scale, while the TM3A has a scale-length of 3 $\frac{1}{4}$ inches. On both, the graduations are in volts and decibels. The pre-amplifier sections of both meters provide up to 80 dB of gain delivering 150 mV max. r.m.s. output, which is phase-inverted. Worst-case input conditions (on the 15 μ V range) are quoted

Frequency Selective Level Meter

INTENDED for use with high-density carrier systems, h.f. radio equipment, microwave systems, and satellite communications equipment the Type 305A frequency selective level meter and tracking signal generator by Philco-Sierra (U.S.A.) will also function as a wave analyser. This instrument consists of three units. (1) The 305 tuning unit which provides all required tuning signals to operate the other units, which are a level meter, signal generator, and an auxiliary spectrum display unit. It consists of a frequency synthesiser, coarse tuning system, fine tuning system, frequency counter, and digital display unit. (2) The 305 meter provides level measurements within the range -109 to +22 dBm from 1 kc/s to 32.1 Mc/s. An expansion switch permits

selection of normal or expanded meter scales, and in the expanded model the meter range is +2 dB to -2 dB with a resolution of 0.05 dB. The overall selectivity of the level meter is controlled by a two-position front panel switch providing bandwidths of 250 c/s and 3.1 kc/s. (3) The signal generator provides the r.f. signal for the tracking generator function of the complete instrument. There are two built-in attenuators with steps of 10 dB and 1 dB plus fine control, digital display indicates the attenuator setting. Level increments as fine as 0.01 dB can readily be resolved. This signal generator includes a precision transfer standard for monitoring the output level, and the absolute accuracy of the output level monitoring at 0 dB is ± 1 dB. Wessex Electronics Ltd., Royal London Buildings, Baldwin Street, Bristol 1.

WW 313 for further details

as 2 M Ω shunted by 50 pF between 200 c/s and 20 kc/s, improving to better than 4.3 M Ω in parallel with 20 pF above 50 mV, over the full frequency-range. The amplifiers may be loaded with 200 k Ω and 50 pF with negligible deterioration in performance. They are also fairly robust, surviving up to 30 V a.c. at over 20 kc/s on the most sensitive range. Accuracy is given as $\pm 1\%$ of reading, $\pm 1\%$ f.s.d. and $\pm 1 \mu$ V at 1 kc/s. Maximum input noise figures are 5 μ V r.m.s. on the 15 μ V range, with the input shorted, and 20 μ V on the 50 μ V range with 100 k Ω source impedance. The effect of using the narrower (10 c/s to 10 kc/s, -3 dB filter on the TM3B is to halve these figures. Both microvoltmeters will operate for a thousand hours on a single PP9 battery, and a mains converter is available. Levell Electronics Ltd., Park Road, High Barnet, Herts.

WW 311 for further details

Stereo Amplifier

AT 10 W per channel and 1 kc/s into 15 Ω the total harmonic distortion for the Sinclair 60 stereo amplifier is given as 0.08%. The circuitry of this instrument employs 28 silicon transistors with complementary symmetry in the output stages. Five transistors per channel are used in the pre-amplifier stages. The power outputs per channel (both channels operating) in I.H.F.M. music ratings are 30 W into 8 Ω and 24 W into 15 Ω . In I.H.F.M. continuous ratings the outputs are halved. Total harmonic distortion at 1 kc/s (both channels operating) is given as 0.1% at 15 W into 8 Ω . The noise level with the volume control at maximum is less than -60 dB on all inputs. The frequency response is said to be ± 1 dB from 20 c/s to 100 kc/s. The controls include two buttons providing three h.f. cut-off frequencies, and three input selection buttons providing equalization for five inputs. The inputs are magnetic pickup 2.7 mV into 47 k Ω (R.I.A.A.); ceramic pickup 2.7 mV adjustable to 160 mV into 10 k Ω (R.I.A.A.); and radio tuner 17 mV adjustable to 1 V into 1 M Ω . Tape head input is 2.5 mV into 47 k Ω (N.A.B. 7.5 in/s); auxiliary 3 mV into 3 k Ω adjustable to 2 V into 1 M Ω . The outputs consist of speaker terminals, stereo headphone sockets ($\frac{1}{4}$ in standard jack), and tape recorder (providing 110 mV r.m.s.). The price for this amplifier which is in a machined steel case with solid rosewood front (2 $\frac{1}{4}$ in high, 8 $\frac{1}{2}$ in wide and 9 $\frac{1}{2}$ in deep) is 55 guineas. Sinclair Radionics Ltd., 22, Newmarket Road, Cambridge.

WW 314 for further details

Stereo Cassette Player

MAINS operated with an output of 750mV r.m.s. per channel, the Sonic Five stereo tape cassette player can be plugged into radiograms, amplifiers, audio plan units or piped music systems. Manufactured by Van der Molen Ltd., 42 Mawney Road, Romford, Essex, it will play back Philips mono or stereo tape cassettes. At a playback speed of 1 $\frac{1}{2}$ in/s it is stated to have a frequency response of 70 c/s to 12 kc/s. Hum and noise contributed by the unit is said to be 50 dB unweighted. The price is 17gn.

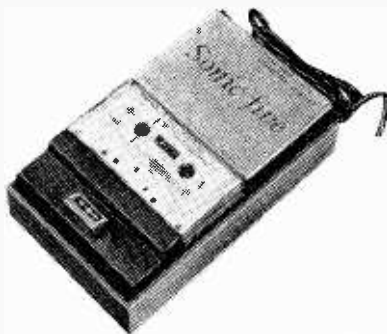

WW 312 for further details

TV Special Effects Unit

THE V.E.L. television Special Effects Unit SS3 is a solid-state device designed to combine the pictures from two c.c.t.v. cameras so that any portion of one picture is replaced by the corresponding portion of the second. This is achieved by means of an ultra-high speed electronic switch. A versatile feature is the provision of an "electric pointer" which may be moved freely about the screen to draw attention and give emphasis to particular details. With this unit the outputs of up to four cameras can be selected in any sequence or combination. The picture may be split between cameras in many different shapes or switched instantly from camera to camera. The SS3 enables transitional wipes to be produced in a variety of patterns, in which one picture is wiped from the screen and instantaneously

replaced with another. Attention has been given to the layout of the operational controls to ensure maximum simplicity of operation. These controls are mounted on a small remote control panel which is connected by only one cable to the main unit, enabling the controls to be mounted in any convenient place, even at some distance from the cameras. Two independent video outputs are provided so that a monitor and a video tape recorder may be fed simultaneously. The system operates on 625 lines but is adjustable for 405 or 525 lines. The input level is 1 V p.p.; input impedance 75 Ω ; output level 1 V p.p. into 75 Ω ; and the bandwidth 6 Mc/s. Video Electronics Ltd., 70 Hanover Street, Leigh, Lancashire.

WW 315 for further details

Negative Capacitance Electrometer

DESIGNED specifically for use in medical schools, research hospitals and universities, the new Keithley Model 605 negative capacitance electrometer is intended to provide a convenient, low-cost method of amplifying signals from microelectrodes. Because the input head containing the amplifiers is very small and weighs only 9oz, it can be incorporated into experimental set-ups with the minimum of disturbance. Model 605 from Keithley Instruments 12415 Euclid, Cleveland, Ohio, U.S.A., is battery operated, and can therefore be used in shielded areas without introducing extraneous electrical interference. The use of electrometer techniques ensures a high input impedance essential in most experimental work connected with nerve cells. Grid cur-

rent is less than 10^{-14} A and current drift is less than 10^{-14} A per day or per degree centigrade without any compensating adjustment. This low grid current minimizes the possibility of polarizing the cell under study. In addition to low grid current, the new Keithley instrument offers input resistance greater than 10^{13} Ω , shunt capacitance adjustable to less than 1 pF with 22 M Ω source and short-circuit noise less than 35 μ V r.m.s. A risetime of less than 20 μ s with a 22 M Ω source permits faithful reproduction of the pulses. For ease of operation and reliability only three operating controls and a power switch are needed to set-up any experiment.

WW 316 for further details

P.C. Capacitors

CAPACITORS with short pins to match the 0.01-in printed circuit board grid are available from Mullard under the type number 344. Because they

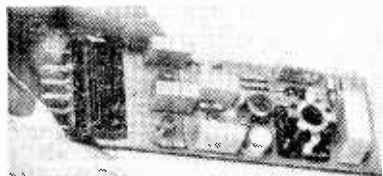

have a regular rectangular outline, a high packing density can be achieved. Stand-off lugs prevent moisture being trapped between capacitor and board and raised markings on the top surface ensure immediate and easy identification. Metallized polyester foil encapsulated in moisture-proof resin is used in the construction of these components. The range extends from 0.01 to 2.2 μ F; values up to 0.22 μ F have a 20% tolerance and values of 0.33 μ F and above have a tolerance of 10%. Type 344 capacitors have a working voltage of 250 V d.c. Mullard Ltd., Mullard House, Torrington Place, London, W.C.1.

WW 317 for further details

Crosshatch Generator

FOR the adjustment of static and dynamic convergence on British colour television receivers, Philips have designed a solid-state dual-standard crosshatch generator, the TVT5M, for mains operation, and TVT5B, for battery operation. The test patterns produced are dots, an 11 \times 15 line cross hatch, and a blank raster. All patterns are provided on 405 lines Band 3 and 625 lines Bands 4 and 5. In addition to the r.f. output there is a video output of 1 V into 75 Ω . The weight is 7 $\frac{1}{2}$ lb and the price is £85. The M.E.L. Equipment Co. Ltd., Manor Royal, Crawley, Sussex.

WW 318 for further details

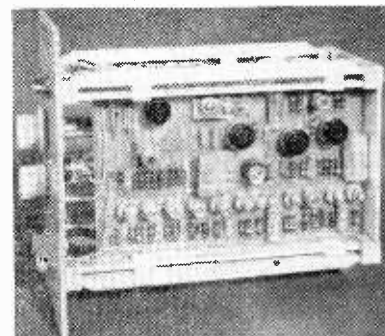

WIDE BAND POWER AMPLIFIER

WITH a frequency response that is said to be flat to within 3 dB from d.c. to 100 kc/s, the low distortion wide-band power amplifier module by Aim Electronics has a variety of applications. It is suitable as a high-fidelity loudspeaker driver for broadcast studios and auditorium work, for driving mechanical or optical chopper systems from the reference channel of a coherent detector, or driving servo motors in servo analysis systems. The power output is greater than 25 W with less than 0.25% harmonic distortion; input impedance is greater than 10 k Ω and the minimum output load impedance is 4 Ω . The input level required for full output is greater than 100 mV r.m.s. The amplifier circuit is protected against short circuits and open circuits. It is self-contained inasmuch that it has a built-in power unit which will work from 105-117 V or 195-260 V at 50/60 c/s. The amplifier is built as a 4in module, and is complementary to other modular amplifiers by the same company. The price is £75. Aim Electronics, Ltd., 71 Fitzroy Street, Cambridge.

WW 319 for further details

Modulator/ Power Supply

THE solid-state modulator 703 by Microtest Ltd. is a bench supply with comprehensive modulation facilities for energizing two-terminal solid-state devices such as Gunn diodes. This instrument provides a voltage source for medium power diodes in c.w., pulse, square wave, and sawtooth form, useful for both experimental and production work. The device current is itself continuously displayed on a three-inch meter. Particularly in the square-wave mode of operation the signal can be amplified by selective amplifiers tuned to frequencies between 1 and 4 kc/s. Provision is made for monitoring (by oscilloscope) the waveform across the diode. Microtest Ltd., 9 Old Bridge Street, Kingston-upon-Thames, Surrey.

WW 320 for further details

Lead-through Capacitors

MOUNTING of the Oxley lead-through capacitor on an earthed chassis provides low frequency or d.c. insulated connection through the chassis with an appropriate capacitance to earth. This capacitance helps to prevent the passage of h.f. energy along the lead-through wire. Tolerances available are: -10%, +80%, and +20%. Working voltage is 350 V d.c. and the range includes 47 pF, 470 pF and 1000 pF values. Oxley Developments Co. Ltd., Priory Park, Ulverston, N. Lancashire.

WW 321 for further details

MICROPHONE MATCHING MODULE

PLUG-IN solid-state modules intended to take the place of conventional microphone matching transformers are manufactured by Channel Electronics (Sussex) Ltd., 2 Fitzgerald Avenue, Seaford, Sussex. These modules, unaffected by stray magnetic fields, are solid-state pre-amplifiers with a sufficiently low input impedance to make them suitable for dynamic ribbon or cardioid microphones. The modules (ET12 and ET 250) can be driven from a d.c. supply of 12 V and 250 V respectively.

WW 322 for further details

Solid State Inverters (November issue page 567).—The company title and address should be Industrial Instruments Ltd., Stanley Road, Bromley, Kent.

WIRELESS WORLD, DECEMBER 1967



THE HOUSE OF BULGIN
AT YOUR SERVICE

PRECISION MADE DELAY FUSES

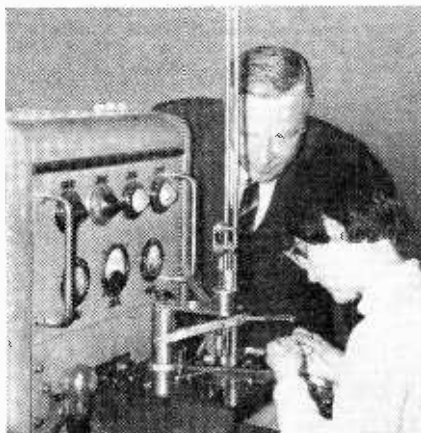

made under strict supervision

- ★ AUTO-MACHINE MADE
- ★ CONSISTENT & ACCURATE
- ★ RELIABLE & LONG-LIVED

The finest range in the World, models and ratings covering all light electrical uses, domestic, professional, industrial. BULGIN DELAY (SURGE-RESISTING) FUSE-LINKS are efficient, consistent, uniform, reliable, long-lived, accurate, low-priced, readily available and fully guaranteed.

THOUSANDS IN USE

A battery of special R.F. Heater Automatic Machines (specially manufactured in our own Machines Development Section) perform all operations under close supervision—Tubes are wired, Caps are added (and sealed on immovably). Elements are internally soldered, and Mech./Elec. criteria are fully tested.

- ★ AVAILABLE FROM STOCK
- ★ VERY LOW PRICED
- ★ CLIMATIC-SEALED

SPRING DELAY FUSES $\frac{1}{4}'' \times \frac{1}{4}''$ & $1''$, $\frac{3}{16}'' \phi \times \frac{5}{8}''$, 5mm. $\phi \times 20$ mm.

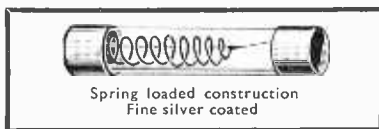

Spring loaded construction
Fine silver coated



Label with full rating
and colour coded

List No.	Size	Carrying Rating Amps
F.283/Rating	$1\frac{1}{4}'' \times \frac{1}{4}'' \phi$.05 .06 .10 .15 .25 .50 .65 .80 1.0 1.5 2.0 3.0 3.5 4.0 5.0
F.312/Rating	$1'' \times \frac{1}{4}'' \phi$.50 1.0 1.5 2.0 3.0 5.0
F.310/Rating	$\frac{3}{8}'' \times \frac{1}{8}'' \phi$.50 1.0 1.5 2.0
F.286/Rating	20 mm. \times 5mm. ϕ	.10 .15 .25 .50 .75 1.0 1.5 2.0

'PAK' DELAY FUSES $\frac{1}{4}'' \phi \times \frac{1}{4}''$



P.A.K.1	.250A.	P.A.K.3	.750A.	P.A.K.5	1.5A.
P.A.K.2	.500A.	P.A.K.4	1.0A.	P.A.K.6	2.0A.

A. F. BULGIN & CO. LTD.,
Bye Pass Rd., Barking, Essex.
Tel: R1Ppleway 5588 (12 lines)

MANUFACTURERS AND SUPPLIERS OF RADIO
AND ELECTRONIC COMPONENTS TO

ADMIRALTY	MINISTRY OF WORKS	B.S.C.
WAR OFFICE	MINISTRY OF AVIATION	G.P.O.
AIR MINISTRY	MINISTRY OF SUPPLY	I.T.A.
HOME OFFICE	RESEARCH ESTABLISHMENTS	N.P.L.
CROWN AGENTS	U.K.A.E.A.	D.S.L.R.

WW-121 FOR FURTHER DETAILS

DECEMBER MEETINGS

Tickets are required for some meetings: readers are advised, therefore, to communicate with the society concerned

LONDON

- 1st. I.E.E.—“Resonant transfer” by Dr. A. Fettweis at 5.30 at Savoy Pl., W.C.2.
- 5th. I.E.E.—Annual general meeting at 6.0 followed by the presidential address of Major General Sir Leonard Atkinson at the London School of Hygiene and Tropical Medicine, Keppel St., W.C.1.
- 7th. Inst. of Electronics.—“Solid state microwave devices” by E. B. B. Callick at 6.45 at the London School of Hygiene & Tropical Medicine, Keppel St., W.C.1.
- 7th. R.T.S.—“Electronic conversion between European and North American television standards” by E. R. Rout at 7.0 at the I.T.A., 70 Brompton Rd., S.W.3.
- 8th. I.E.E.—Colloquium on “Automatic testing of electronic devices, components and circuits” at 10 a.m. at Savoy Pl., W.C.2.
- 12th. I.E.E. & I.E.R.E.—“The evaluation and prediction of equipment reliability” by P. Cox, V. J. McMillan and Mrs. D. Crook at 6.0 at the London School of Hygiene and Tropical Medicine, Keppel St., W.C.1.
- 14th. I.E.E.—“Computer methods for electrostatic field determination and ray tracing in image intensifier” by A. Stark at 5.30 at Savoy Pl., W.C.2.
- 15th. I.E.E. & I.E.R.E.—Discussion on “Applications of thin films and integrated circuits in medical and biological instrumentation” at 2.30 at Savoy Pl., W.C.2.
- 18th. I.E.E.—Discussion on “Recent developments of inductive radio standards” at 5.30 at Savoy Pl., W.C.2.
- 19th. I.E.E.—“The management of men and money in an electronics company” by Dr. F. E. Jones at 5.30 at Savoy Pl., W.C.2.
- 20th. Inst. Navigation.—Symposium on “Instrument approach criteria” at 2.15 at the Royal Institution of Naval Architects, 10 Upper Belgrave St., S.W.1.

BEDFORD

- 15th. I.E.E.—“Communications by satellite” by H. E. Pearson at 7.0 at Mander College.

BELFAST

- 12th. I.E.E.—“Ever decreasing circles—microelectronics” by R. G. Dixon at 6.30 at the Ashby Institute.

BIRMINGHAM

- 5th. S.E.R.T.—“Record playing units” by E. Mortimer at 7.30 in the Electronic and Electrical Eng'g Dept., the University, Edgbaston.
- 7th. I.E.R.E.—“The University of Birmingham instrumentation in the Ariel III satellite” by I. H. Wager at 7.15 in the Electronic and Electrical Eng'g Dept., the University, Edgbaston.

BRISTOL

- 4th. I.E.R.E.—“Electronic telephone exchanges” by Prof. J. E. Flood at 6.0 in the Queen's Building, the University.

CAMBRIDGE

- 7th. I.E.E. & I.E.R.E.—“Scanning electron microscopy—its use in the evaluation of semiconductor devices and materials” by Dr. P. R. Thornton at 8.0 in the University Eng'g Labs., Trumpington St.

CARDIFF

- 8th. S.E.R.T.—“Modern design trends in communication receivers” by D. Thomas at 7.30 at Llandaff Technical College, Western Avenue.
- 13th. I.E.R.E. & I.E.E.—“Domain originated functional integrated circuits” by M. P. Wasse at 6.30 at the Welsh College of Advanced Technology.

FARNBOROUGH

- 7th. I.E.R.E.—“Radar measurements on meteor trails” by Dr. J. A. Clegg at 7.0 at the Technical College.

GLASGOW

- 14th. I.E.E. & I.E.R.E.—“Radio astronomy” by I. W. Sheffield at 7.0 at the Inst. of Engineers and Shipbuilders.

EDINBURGH

- 13th. I.E.E. & I.E.R.E.—“Radio astronomy” by I. W. Sheffield at 7.0 at the University.

GRIMSBY

- 13th. Soc. Instrument Tech.—“Lasers” by E. B. Callick at 7.30 at the Yarborough Hotel.

HALIFAX

- 20th. I.E.R.E.—“Electronically controlled adjustable speed drives” by P. A. Bennett at 6.0 at the Percival Whitley College of Further Education, Dept. of Eng'g, Francis St.

HOVE

- 6th. I.E.E.—“Electronics in the power sector” by J. S. Ekbery at 6.30 at S.E.E.B. Offices.

LEICESTER

- 6th. R.T.S.—“C.C.T.V. with V.T.R.” by R. W. Richards at 7.15 at the Vaughan College, St. Nicholas St.
- 7th. I.E.R.E. & I.E.E.—“Problems and developments in B.B.C. overseas broadcasting” by Dr. K. R. Sturley at 6.30 at the Regional College of Technology.

LIVERPOOL

- 13th. I.E.R.E.—“Microelectronics—its effect on industry and education” by K. J. Dean at 7.0 at the Regional College of Technology.
- 13th. I.E.E.T.E.—“Mass spectrometry” by K. Dickens at 7.0 at Building and Design Centre, Hope St.
- 14th. S.E.R.T.—“Basic computer circuitry” by M. Haynes at 7.0 at Riversdale Technical College, Riversdale Road.

MAIDSTONE

- 4th. I.E.E.—“Engineering of the Independent Television service” by P. A. T. Bevan at 7.0 at the “Wig and Gown” Hotel.

MALVERN

- 18th. I.E.R.E.—“Measurement of time and frequency” by Dr. L. Essen at 7.0 at the Abbey Ballroom.

MANCHESTER

- 6th. Soc. Environmental Eng.—“Three lectures on “Design for reliability” at 3.0

at the Main Bldg of the Royal College of Advanced Technology, Salford.

- 13th. I.E.E. Grads.—Convention on “Lasers” at 6.45 at U.M.I.S.T.
- 14th. I.E.R.E., I.E.E. & R.T.S.—“The design of a fully transistorised colour television receiver” by J. W. Russell, S. C. Jones and R. Gray at 7.15 at the Renold Bldg, the College of Science and Technology, Altrincham St.

NEWCASTLE-UPON-TYNE

- 4th. I.E.E.—“Holography” by Dr. W. R. Fardart at 6.30 at Rutherford College of Technology.
- 6th. S.E.R.T.—“Chromoscan” by J. Hambleton at 7.15 at the Charles Trevelyan Technical College, Maple Terrace.
- 13th.—I.E.R.E.—“Holography” by J. D. Redman at 6.0 at the Inst. of Mining and Mechanical Engrs, Neville Hall, Westgate Rd.

NORTHAMPTON

- 12th. I.E.E.—“Radio interference suppression” by G. A. Jackson at 6.30 at E.M.E.B. Social Club, Angel Lane.

PORTSMOUTH

- 13th. I.E.R.E.—“Adaptive astable/monostable circuits in class D amplifiers” by D. C. Smith at 6.30 at Highbury Technical College, Cosham.

READING

- 12th. I.E.R.E.—“Active filters” by E. F. Good and F. E. J. Girling at 7.30 at J. J. Thomson Physical Lab., the University.

SHEFFIELD

- 6th. I.E.E.—“The behaviour of thyristor amplifiers in closed loop control systems” by Dr. F. Fallside at 6.30 at the Royal Victoria Hotel.

STAFFORD

- 14th. I.E.R.E.—“Integrated circuits” by H. Blackburn at 7.15 at the College of Further Education, Tenterbanks.

TORQUAY

- 14th. I.E.E.—“The future use of solid-state devices in the microwave field” by J. E. Carroll at 2.30 at the Electric Hall.

WELWYN GARDEN CITY

- 19th. S.E.R.T.—“Logic circuits” by R. C. Ripplingale at 7.0 at Mid Herts College of Further Education, The Campus.

WHITEHAVEN

- 5th. Soc. Instrument Tech.—“Techniques of hi-fi reproduction” at 7.15 at the College of Further Education.

CONFERENCES AND EXHIBITIONS

LONDON

- Nov. 17-Dec. 2 Mullard House
Colour Television Fair
(Mullard Ltd., Torrington Pl., W.C.1)
- Nov. 30-Dec. 1 Savoy Place
Photographic Granularity
(Royal Photographic Soc., 16 Princes Gate, S.W.7)
- Dec. 5-7 Savoy Place
Electrical Methods of Machining & Forming
(I.E.E., Savoy Pl., W.C.2)



MANUFACTURERS OF THE WORLD'S FINEST SOLDERING INSTRUMENTS

CATALOGUE SURVEY No. 2 THE L.70.

THIS IS THE SMALLEST INSTRUMENT IN THE RANGE AND WEIGHING ONLY $4\frac{1}{2}$ OZS. IT IS LIGHT AND EASY TO HANDLE WITH A STANDARD BIT SIZE OF $\frac{1}{8}$ INCH IT CAN BE OBTAINED WITH ANY BIT SIZE FROM $\frac{1}{32}$ " TO $\frac{3}{16}$ " WHICH ENABLES THE USER TO UNDERTAKE THE SMALLEST WORK WITH AN INSTRUMENT WHICH IS STILL LARGE ENOUGH TO HAVE THE MINIMUM MECHANICAL CLEARANCES SO ESSENTIAL TO ELECTRICAL SAFETY.

AVAILABLE TEMPERATURE RANGE 250° TO 410°C. IN ANY VOLTAGE FROM 6-250 VOLTS.

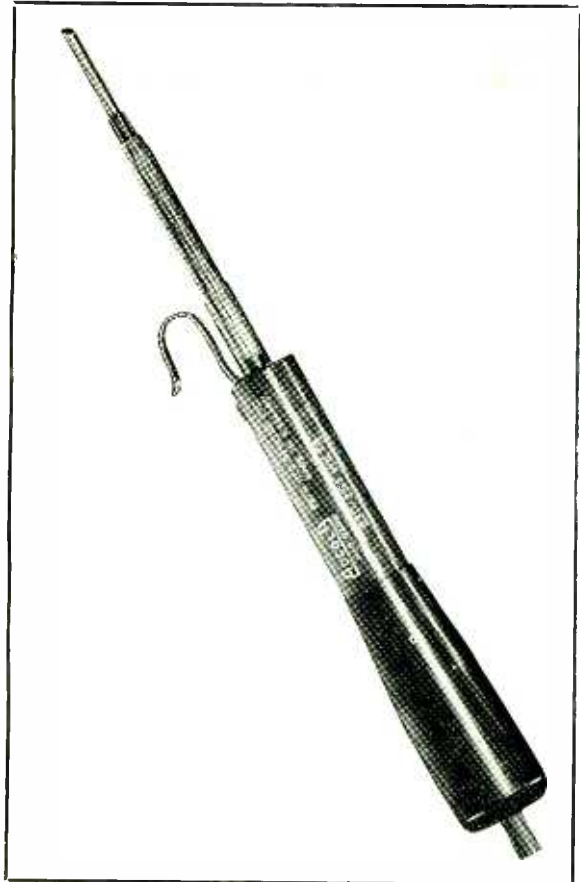

Send for details to

HEAD OFFICE SALES & SERVICE

ADCOLA PRODUCTS LTD
ADCOLA HOUSE, GAUDEN ROAD,
LONDON, S.W. 4.

Telephones: 01-622-0291/3

Telegrams: SOLJOINT, LONDON, S.W.4

AUSTRALIAN ASSOCIATES: ADCOLA PRODUCTS PTY. LTD., 673 WHITEHORSE ROAD, MONT ALBERT, MELBOURNE
AGENTS IN ALL LEADING COUNTRIES



In addition to
**Ersin Multicore
 5 Core Solder**
 we make these products to help
 industry and laboratories

**special products for the soldering
 of printed circuits**

A complete range of products for the soldering of printed circuits, including:
 P.C. 2 Dip Cleaner P.C. 10A Activated Surface Preservative
 P.C. 21A Printed Circuit Liquid Flux P.C. 51 Finishing Enamel.
 Solid Solder Wire, Solder Sticks, Solder Ingots and Ersin Multicore
 5-core Solder Wire for direct application to panels.

**Mark 2
 solderability
 test
 machine**

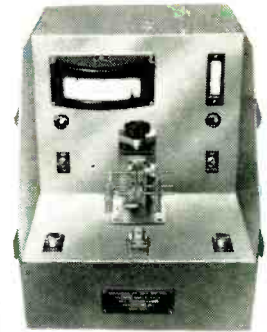

Incorporates many new features, including semi-automatic electrical timing, proportional temperature control, remote controlled specimen lowering system and a temperature meter calibrated to an accuracy of 0.25% full scale deflection at the test temperature. The machine can reduce production costs by instantly checking the solderability of components with wire terminations. It complies with B.S.I. and proposed M. of D. and International Solderability Test Specifications.

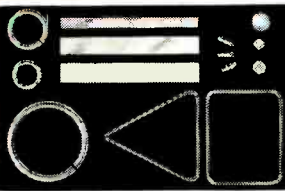

**solder tape, rings,
 preforms, washers,
 discs, and pellets**

Made in a wide range of solid or cored alloys. Tape, rings and pellets are the most economical to use.

liquid fluxes

7 standard non-corrosive Ersin Liquid Fluxes, all comply with D.T.D. and Mil specifications. Arax Acidic Liquid Flux, the residue is easily removed, is faster than zinc chloride types but much less corrosive. In 1-gallon or 5-gallon non-returnable containers.

**3a automatic soldering
 machine**

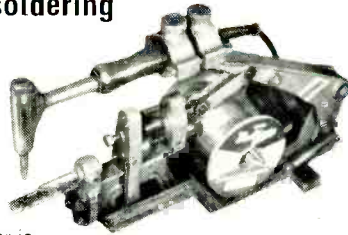

Specially designed for manufacturing processes involving repetitive soldering operations. An exact quantity of Ersin Multicore Solder is automatically fed at each downward stroke. It can be operated by foot treadle or compressed air system, or may be connected to form part of an automatic assembly sequence.



Arax 4-core acid cored solder

Used in 38 industries it has replaced tinman's and blowpipe solders, fluid and paste fluxes and killed spirits for rapid and precision soldering in metal fabrication processes. Arax Flux—exclusive to Multicore—has the fastest speed of flux in any cored solders. Flux residue is easily removable with water or, where flame heating is employed, is entirely volatilised. Residue will not contaminate plating baths. No pre-cleaning is necessary and the speed ensures that the solder will flow between the laps by capillary action, thus using the minimum amount of solder. Not recommended for wire to tag joints in radio or electrical equipment.

Bib accessories can be supplied in bulk packings at very competitive prices

**wire stripper
 and cutter**



Strips insulation without nicking wires, cuts wires and cables cleanly. Model 3 is semi-permanently adjusted. Model 8 incorporates a unique 8-gauge selector.

1 5 6 4 4 **A**

**recording tape
 splicer**



Precision made, chrome plated complete with razor cutter. Provides quick and accurate tape editing. Standard model for 1/4" tape. NEW 3/8" type is available for computer and video tape.

B

instrument cleaner

Anti-static. Specially formulated for cleaning delicate instrument panels, plastic, chrome, glass and printed surfaces. Antiseptic, non-toxic, non-flammable, does not smear. Used and recommended by leading electronic manufacturers. In 1-gallon and 5-gallon containers and 4 fl. oz. bottles.



C

**tape head
 maintenance kit
 size E**



Cleans tape heads and all parts of the tape path of magnetic tape decks. Applicator and Polisher Tools and Sticks are available separately.

D

For further information please apply on your Company's note paper mentioning the product references
 Dept. WW, Multicore Solders Limited, Hemel Hempstead, Herts. Telephone: Hemel Hempstead 3636

WW-002 FOR FURTHER DETAILS